

Service Manual

R32 Sky-Air RZAG-M

Indoor unit

**FCAHG/FCAG/FFA/FBA/
FDA/FAA/FHA/FUA/FVA/
FNA 71~140**

Outdoor unit

RZAG-MV/Y

RZASG-MV/Y



The present publication is drawn up by way of information only and does not constitute an offer binding upon Daikin Europe N.V.. Daikin Europe N.V. has compiled the content of this publication to the best of its knowledge. No express or implied warranty is given for the completeness, accuracy, reliability or fitness for particular purpose of its content and the products and services presented therein. Specifications are subject to change without prior notice. Daikin Europe N.V. explicitly rejects any liability for any direct or indirect damage, in the broadest sense, arising from or related to the use and/or interpretation of this publication. All content is copyrighted by Daikin Europe N.V..

Part 1. Introduction	7
1.1. Version log	7
1.2. Safety precautions	8
1.2.1. Meaning of symbols	8
1.2.2. Warnings	8
1.2.3. Cautions	10
1.2.4. Information	11
1.3. General operation	12
1.4. How to use	13
1.4.1. Interactive information flow	13
1.4.2. Parts of the book	14
1.4.2.1. The introduction chapter	14
1.4.2.2. The troubleshooting chapter	14
1.4.2.3. The repair chapter	14
1.4.2.4. The maintenance chapter	14
1.4.2.5. Appendices	14
1.4.3. Contact information	14
 Part 2. Troubleshooting	 15
2.1. Error codes check	15
2.1.1. Error codes via remote controller	15
2.1.1.1. Error codes via wired remote controller BRC1E	15
2.1.1.2. Error codes via wireless remote controller BRC7	17
2.1.1.3. Error codes via indoor remote controller BRC1H	19
2.1.2. Error codes via outdoor unit PCB	21
2.1.2.1. How to retrieve error codes	21
2.2. Error based troubleshooting	23
2.2.1. Indoor unit	24
2.2.1.1. "A0-11" – Detection of refrigerant leak	24
2.2.1.2. "A1-01" – Indoor unit PCB abnormality	24
2.2.1.3. "A3-00" – Drain water level system abnormality	24
2.2.1.4. "A6-00" – Indoor unit fan motor abnormality	25
2.2.1.5. "AJ-00" – Capacity setting abnormality	25
2.2.1.6. "C1-00" – Transmission error (indoor & adapter PCB)	26
2.2.1.7. "C4-00" – Liquid pipe thermistor for heat exchanger abnormality	26
2.2.1.8. "C5-00" – Intermediate heat exchanger thermistor abnormality	26
2.2.1.9. "C9-00" – Suction air thermistor abnormality	27
2.2.1.10. "CC-00" – Humidity sensor system abnormality	27
2.2.1.11. "CH-01" – Refrigerant leakage sensor abnormality	28
2.2.1.12. "CJ-00" – Remote controller thermistor abnormality	28
2.2.2. Outdoor unit	29
2.2.2.1. "E1-00" – Outdoor unit PCB abnormality	29
2.2.2.2. "E3-00" – Discharge pressure abnormality	29
2.2.2.3. "E4-00" – Suction pressure abnormality	30
2.2.2.4. "E5-00" – Compressor motor lock or overheated	30
2.2.2.5. "E7-00" – Fan motor abnormality	31
2.2.2.6. "E9-00" – Electronic expansion valve abnormality	31
2.2.2.7. "F3-00" – Discharge pipe temperature abnormality	32
2.2.2.8. "H3-00" – High pressure switch abnormality	33
2.2.2.9. "H4-00" – Low pressure switch abnormality	33
2.2.2.10. "H9-00" – Outdoor air temperature thermistor abnormality	33
2.2.2.11. "J3-00" – Discharge pipe thermistor abnormality	34
2.2.2.12. "J5-00" – Suction pipe thermistor abnormality	34
2.2.2.13. "J6-00" – Outdoor heat exchanger thermistor abnormality	34
2.2.2.14. "J7-00" – Intermediate heat exchanger thermistor abnormality	35
2.2.2.15. "J8-00" – Liquid pipe thermistor abnormality	35
2.2.2.16. "L1-00" – Outdoor main PCB abnormality	35

2.2.2.17. "L5-00" – Inverter instantaneous overcurrent (AC output)	36
2.2.2.18. "L8-00" – Electronic thermal overload	37
2.2.2.19. "L9-00" – Stall prevention time lag	37
2.2.2.20. "LC-00" – Transmission system abnormality	38
2.2.2.21. "P1-00" – Open phase or power supply voltage imbalance	38
2.2.2.22. "P4-00" – Radiating fin temperature sensor abnormality	39
2.2.2.23. "PJ-00" – Capacity setting abnormality	39
2.2.3. System	40
2.2.3.1. "U0-00" – Refrigerant shortage	40
2.2.3.2. "U1-00" – Reverse phase or open phase	40
2.2.3.3. "U2-00" – Power supply abnormality or instantaneous power failure	41
2.2.3.4. "U4-00" – Transmission abnormality between indoor unit and outdoor unit	41
2.2.3.5. "UA-00" – Improper combination of indoor unit and outdoor unit	42
2.2.3.6. "UF-00" – Wiring and piping mismatch	42
2.2.4. Others	43
2.3. Symptom based troubleshooting	44
2.3.1. Indoor unit	44
2.3.2. Outdoor unit	44
2.3.3. System	44
2.3.4. Others	44
2.4. Component checklist	45
2.4.1. Indoor unit	46
2.4.1.1. Fan motor	46
2.4.2. Outdoor unit	47
2.4.2.1. 4-way valve	47
2.4.2.2. Compressor	49
2.4.2.3. Electronic expansion valve	51
2.4.2.4. Fan motor	53
2.4.2.5. High pressure switch	54
2.4.2.6. Low pressure switch	55
2.4.2.7. Main PCB	56
2.4.2.8. Refrigerant thermistors	58
2.4.3. System	61
2.4.4. Others	61
2.5. Other capacity range	61

Part 3. Repair 63

3.1. Refrigerant repair procedures	63
3.1.1. Refrigerant piping handling	63
3.1.2. Recovery procedure	63
3.1.2.1. Outdoor unit casing	63
3.1.3. Refrigerant pump down	65
3.1.3.1. Small outdoor unit	65
3.1.3.2. Large outdoor unit	66
3.1.4. Piping repair procedures	66
3.2. Service tools	67
3.3. Unit specific repair procedures	68
3.3.1. Indoor unit	68
3.3.2. Outdoor unit	69
3.3.2.1. Basic removal	69
3.3.2.2. Replacing thermistor	75
3.3.2.3. Replacing 4-way valve body	77
3.3.2.4. Replacing 4-way valve coil	78
3.3.2.5. Replacing accumulator assembly	79
3.3.2.6. Replacing compressor	79
3.3.2.7. Replacing DC fan motor assembly	82
3.3.2.8. Replacing electrical noise filter	83
3.3.2.9. Replacing expansion valve body	85
3.3.2.10. Replacing expansion valve motor	87
3.3.2.11. Replacing solenoid valve	88

3.3.2.12. Replacing solenoid valve coil	90
3.3.2.13. Replacing high pressure switch	91
3.3.2.14. Replacing inverter PCB	92
3.3.2.15. Replacing low pressure switch	92
3.3.2.16. Replacing main PCB	94
3.3.2.17. Replacing propeller fan blade assembly	101

Part 4. Maintenance 103

4.1. Indoor unit	103
4.1.1. General maintenance indoor unit	103
4.2. Outdoor unit	104
4.2.1. General maintenance outdoor unit	104

Part 5. Appendix 105

5.1. Field setting	107
5.1.1. Indoor unit	107
5.1.1.1. Retrieve field settings BRC1E	107
5.1.1.2. Retrieve field settings BRC7	109
5.1.1.3. Retrieve field settings BRC1H	110
5.1.1.4. Sky-Air R32 indoor field settings	112
5.1.2. Outdoor unit	113
5.1.2.1. Retrieve field settings OU mode 1 / mode 2	113
5.1.3. Remote controller	114
5.2. Detailed information setting mode	115
5.2.1. Indoor unit	115
5.2.2. Outdoor unit	115
5.2.3. Remote controller	117
5.2.3.1. Quiet (Low Noise) Operation	117
5.2.3.2. I-Demand Function	118
5.2.3.3. Setting for Low Humidity Application	119
5.2.3.4. Defrost Operation	121
5.3. Wiring diagram	123
5.3.1. Indoor unit	123
5.3.2. Outdoor unit	124
5.3.3. Field wiring	127
5.4. Piping diagram	128
5.4.1. Indoor unit	128
5.4.2. Outdoor unit	128
5.5. Component overview of unit	129
5.5.1. Indoor unit	129
5.5.2. Outdoor unit	130
5.6. Product specific information	132
5.6.1. Error codes	132
5.6.1.1. "E9-00" - Electronic expansion valve abnormality	132
5.6.1.2. "F3-00" - Discharge pipe temperature abnormality	132
5.6.2. Component checklist	132
5.6.2.1. How to activate inverter test	132
5.6.2.2. Component checklist	132
5.7. Switch box	133
5.7.1. Indoor unit	133
5.7.2. Outdoor unit	133
5.8. Field information report	133

Figure 3-1: 1 service port at the stop valves	64
Figure 3-2: 3 service ports at the stop valves	65
Figure 3-3: Removing the top plate assembly	69
Figure 3-4: Removing the front plate	71
Figure 3-5: Removing the front plate assembly	72
Figure 3-6: Removing the cover	73
Figure 3-7: Removing the piping cover	73
Figure 3-8: Removing the right side plate	74
Figure 3-9: Replacing a thermistor	75
Figure 3-10: Thermistor location	76
Figure 3-11: Removing 4-way valve body	77
Figure 3-12: Removing 4-way valve body	78
Figure 3-13: Removing stop valve mounting plate	80
Figure 3-14: Removing compressor	81
Figure 3-15: Removing the DC fan motor assembly	83
Figure 3-16: Removing the electrical noise filter (1-phase)	84
Figure 3-17: Removing the electrical noise filter (3-phase)	85
Figure 3-18: Removing expansion valve	86
Figure 3-19: Removing expansion valve motor	87
Figure 3-20: Removing expansion valve motor	88
Figure 3-21: Removing solenoid valve	89
Figure 3-22: Removing solenoid valve coil	90
Figure 3-23: Removing high pressure switch	91
Figure 3-24: Removing low pressure switch	93
Figure 3-25: Installation	93
Figure 3-26: Removing the main PCB assembly (1-phase)	95
Figure 3-27: Stripping the main PCB assembly 1-phase (rear)	96
Figure 3-28: Removing the main PCB assembly (3-phase)	98
Figure 3-29: Stripping the main PCB assembly 3-phase (front)	99
Figure 3-30: Stripping the main PCB assembly 3-phase (rear)	100
Figure 3-31: Removing the propeller fan blade assembly	101
Figure 5-1: Wiring diagram - indoor unit	123
Figure 5-2: Wiring diagram - outdoor unit RZAG-MY1, RZASG-MY1, AZAS-MY1	124
Figure 5-3: Wiring diagram - outdoor unit AZAS71MV1, RZASG71MV1	125
Figure 5-4: Wiring diagram - outdoor unit RZAG71MV1, RZASG100MV1, AZAS100MV1	126
Figure 5-5: Wiring diagram - outdoor unit RZAG100-140MV1, RZASG125-140MV1, AZAS125-140MV1	127
Figure 5-6: Piping diagram - indoor unit	128
Figure 5-7: Piping diagram - outdoor unit	128
Figure 5-8: Components overview - indoor unit	129
Figure 5-9: Components overview - outdoor unit 71	130
Figure 5-10: Components overview - outdoor unit 100-140	131

Part 1. Introduction

This part contains the following chapters:

Version log	7
Safety precautions.....	8
General operation.....	12
How to use	13

1.1. Version log

Version code	Description	Date
ESIE17-08	Document release	15/11/2018
ESIE17-08A	Extra information of general maintenance for indoor units. Added R32 sensor error codes A0-11 and CH-01. Added Madoka remote controller. Correct information on thermistor table.	23/04/2020
ESIE17-08B	Correct the positions of expansion valves in the "Component overview of the unit".	10/12/2020

1.2. Safety precautions

The precautions described in this document cover very important topics, follow them carefully.

All activities described in the service manual must be performed by an authorized person.

If you are not sure how to install, operate or service the unit, contact your dealer.









In accordance with the applicable legislation, it might be necessary to provide a logbook with the product containing at least: information on maintenance, repair work, results of tests, stand-by periods, ...

Also, at least, following information must be provided at an accessible place at the product:

- Instructions for shutting down the system in case of an emergency
- Name and address of fire department, police and hospital
- Name, address and day and night telephone numbers for obtaining service













In Europe, EN378 provides the necessary guidance for this logbook.

1.2.1. Meaning of symbols

	WARNING Indicates a situation that could result in death or serious injury.
	WARNING: RISK OF ELECTROCUTION Indicates a situation that could result in electrocution.
	WARNING: RISK OF BURNING Indicates a situation that could result in burning because of extreme hot or cold temperatures.
	WARNING: RISK OF EXPLOSION Indicates a situation that could result in explosion.
	WARNING: RISK OF POISONING Indicates a situation that could result in poisoning.
	WARNING: RISK OF FIRE Indicates a situation that could result in fire.
	CAUTION Indicates a situation that could result in equipment or property damage.
	INFORMATION Indicates useful tips or additional information.

1.2.2. Warnings

	WARNING Improper installation or attachment of equipment or accessories could result in electric shock, short-circuit, leaks, fire or other damage to the equipment. Only use accessories, optional equipment and spare parts made or approved by Daikin.
---	---

	<p>WARNING</p> <p>Make sure installation, testing and applied materials comply with applicable legislation (on top of the instructions described in the Daikin documentation).</p>
	<p>WARNING</p> <p>Make sure the work site environment is clean and safe to work in. Beware of spilled fluids, like water, oil or other substances. Protect bystanders from injury and property from possible damage cause by service works.</p>
	<p>WARNING</p> <p>Wear adequate personal protective equipment (protective gloves, safety glasses,...) when installing, maintaining or servicing the system.</p>
	<p>WARNING</p> <p>Tear apart and throw away plastic packaging bags so that nobody, especially children, can play with them. Possible risk: suffocation.</p>
	<p>WARNING</p> <p>Do NOT touch the air inlet or aluminium fins of the unit.</p>
	<p>WARNING</p> <ul style="list-style-type: none"> Do NOT place any objects or equipment on top of the unit. Do NOT sit, climb or stand on the unit.
	<p>WARNING</p> <p>During tests, NEVER pressurize the product with a pressure higher than the maximum allowable pressure (as indicated on the nameplate of the unit).</p>
	<p>WARNING</p> <ul style="list-style-type: none"> Never mix different refrigerants or allow air to enter the refrigerant system. Never charge recovered refrigerant from another unit. Use recovered refrigerant only on the same unit where it was recovered from, or have it recycled at a certified facility.
	<p>WARNING: RISK OF FIRE</p> <ul style="list-style-type: none"> When reconnecting a connector to the PCB, do not apply force or damage the connector or the connector pins on the PCB.
	<p>WARNING: RISK OF BURNING</p> <ul style="list-style-type: none"> Do NOT touch the refrigerant piping, water piping or internal parts during and immediately after operation. It could be too hot or too cold. Give it time to return to normal temperature. If you must touch it, wear protective gloves. Do NOT touch any accidental leaking refrigerant.
	<p>WARNING</p> <p>Always recover the refrigerants. Do NOT release them directly into the environment. Use a recovery pump to evacuate the installation.</p> <p>Take sufficient precautions in case of refrigerant leakage. If refrigerant gas leaks, ventilate the area immediately.</p> <p>Possible risks:</p> <ul style="list-style-type: none"> Excessive refrigerant concentrations in a closed room can lead to oxygen deficiency. Toxic gas may be produced if refrigerant gas comes into contact with fire. <p>Where applicable, pump down the system and close the service valve, before leaving the site if leak was not repaired, to avoid further leaking of the refrigerant.</p>
	<p>WARNING: RISK OF ELECTROCUTION</p> <ul style="list-style-type: none"> Turn OFF all power supply before removing the switch box cover, connecting electrical wiring or touching electrical parts. Where applicable, stop the equipment's operation first and allow (refrigerant) pressure to equalize, before turning OFF the power. Disconnect the power supply for more than 1 minute, and measure the voltage at the terminals of main circuit capacitors or electrical components before servicing. The voltage must be less than 50 V DC before you can touch electrical components. For the location of the terminals, refer to "Wiring diagram" on page 123. Do NOT touch electrical components with wet hands. Do NOT leave the unit unattended when the service cover is removed. Protect electric components from getting wet while the service cover is opened.

	<p>WARNING</p> <ul style="list-style-type: none"> • Only use copper wires. • All field wiring must be performed in accordance with the wiring diagram and installation manual supplied with the product. • If the power cable and lead wires have scratches or deteriorated, be sure to replace them. Damaged cable and wires may cause an electrical shock, excessive heat generation or fire. • Secure all terminal connections and provide proper routing for cables, both inside and outside the switchbox. • NEVER squeeze bundled cables and make sure they do not come in contact with the piping and sharp edges. • Make sure no external pressure is applied to the terminal connections. • Make sure to check the earth wiring. Do NOT earth the unit to a utility pipe, surge absorber, or telephone earth. Improper earth wiring may cause electrical shock. • Make sure to use a dedicated power circuit. NEVER use a power supply shared by another appliance. • Make sure to check the required fuses and/or circuit breakers before starting works.
	<p>WARNING</p> <ul style="list-style-type: none"> • After finishing the electrical work, confirm that each electrical component and terminal inside the electrical components box is connected securely. • Make sure all covers are closed before starting the unit again.
	<p>WARNING</p> <ul style="list-style-type: none"> • The area shall be checked with an appropriate refrigerant detector prior to and during work, to ensure the technician is aware of potentially toxic or flammable atmospheres. • Ensure that the leak detection equipment being used is suitable for use with all applicable refrigerants, i.e. non-sparking, adequately sealed or intrinsically safe.
	<p>WARNING</p> <ul style="list-style-type: none"> • Equipment shall be labelled stating that it has been de-commissioned and emptied of refrigerant. • The label shall be dated and signed. • For appliances containing flammable refrigerants, ensure that there are labels on the equipment stating the equipment contains flammable refrigerant.

1.2.3. Cautions

	<p>CAUTION</p> <p>Provide adequate measures to prevent that the unit can be used as a shelter by small animals. Small animals that make contact with electrical parts can cause malfunctions, smoke or fire.</p>
	<p>CAUTION</p> <ul style="list-style-type: none"> • Make sure water quality complies with EU directive 98/83 EC. • Check the system for leaks after each repair/modification of the water side. • Check drainage system(s) after repairs. • Be careful when tilting units as water may leak.

1.2.4. Information

**INFORMATION**

Make sure refrigerant piping installation complies with applicable legislation. In Europe, EN378 is the applicable standard.

**INFORMATION**

Make sure the field piping and connections are not subjected to stress.

1.3. General operation

- The Sky-Air is typically used for cooling or heating in commercial applications. Some units also have settings to perform technical cooling. The medium which is used to transfer the heat from inside to outside or vice versa, is refrigerant. In case of the RZAG-M, the refrigerant which is used, is R32.
- In case of heating, the compressor builds up pressure and hence the temperature of the refrigerant is increased. The hot refrigerant is blown into the room by a fan which blows over a heat exchanger. Colder refrigerant flows back to the outdoor unit, where temperature is further decreased by expansion through an expansion valve. After the expansion valve, the refrigerant is capable of taking up heat again. This is enabled by a fan that sucks outdoor air over a heat exchanger. This refrigerant is then transported to the compressor where temperature is further built up again and the cycle starts again. For cooling, it's just the other way round.

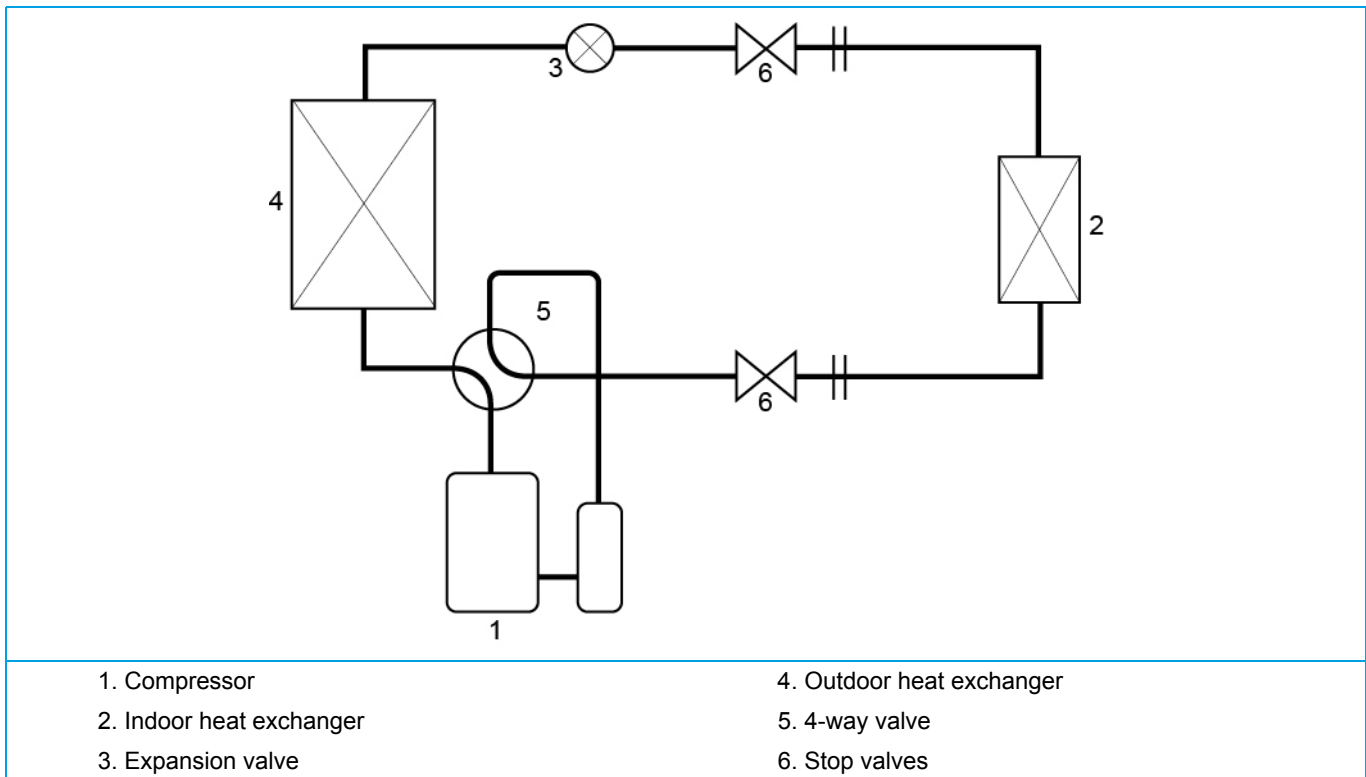

1.4. How to use

1.4.1. Interactive information flow

This Daikin product Service Manual is intended for professional use only. The actions described hereafter, are only to be performed by qualified and certified persons, taking into account the safety precautions mentioned in this manual and the local regulations as well.

By following the diagram below, the reader can find the relevant information related to his/her task. The digital (pdf) version of this book allows direct page access through all active links. When Adobe Acrobat Reader is used, the <Alt> + <Back Arrow> keys or the arrow in the top right-hand corner of this page can be used to return to the previously viewed page.

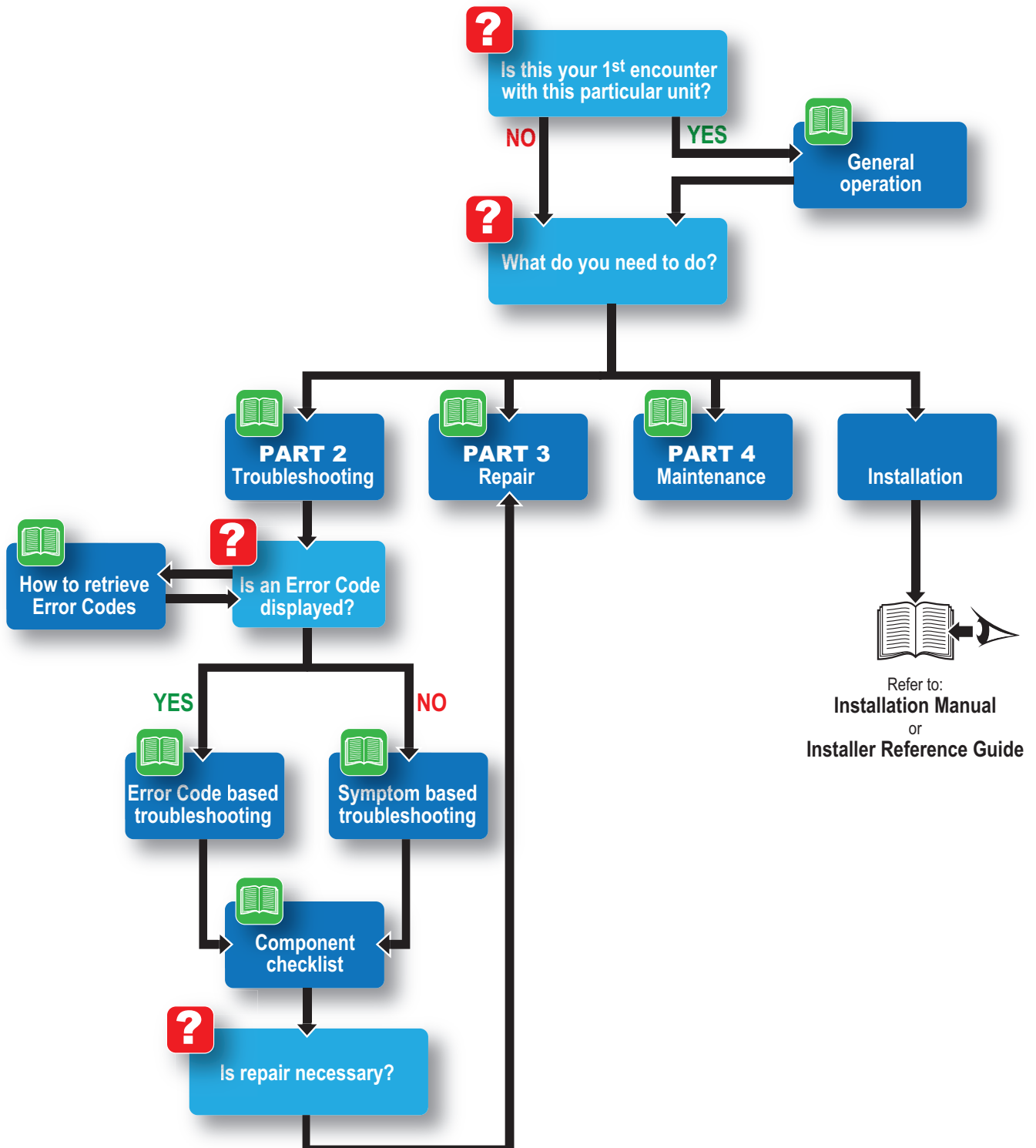

1.4.2. Parts of the book

This Daikin product Service Manual is intended for professional use only. The actions described hereafter, are only to be performed by qualified and certified persons, taking into account the safety precautions mentioned in this manual and the local regulations as well.

As can be observed from the Table of Contents, this manual is split up into several chapters:

1.4.2.1. The introduction chapter

The chapter "Introduction" on page 7 includes the safety precautions, this topic and the general operation description of the product(s) this manual refers to.

1.4.2.2. The troubleshooting chapter

The chapter "Troubleshooting" on page 15 not only deals with the methods to recognize and resolve occurring error codes; it also describes the methods how to solve a problem that does not immediately trigger an error code. Such problems are referred to as 'symptom based'. Both the error code based and symptom based troubleshooting tables, indicate possible causes, the necessary checks and in case required, how to repair. The possible causes have been sorted to probability of occurrence and speed of execution.

1.4.2.3. The repair chapter

The chapter "Repair" on page 63 handles the removal and replacement of the major components in the product and discusses cleaning methods as well if applicable, such as for filters. Where applicable, refrigerant handling precautions are mentioned for certain actions; please consider these carefully for your own safety.

1.4.2.4. The maintenance chapter

The chapter "Maintenance" on page 103 of this manual describes the maintenance intervals and procedures to be performed on the product. Remember that a well maintained product, is a more reliable and efficient product.

1.4.2.5. Appendices

Finally, the service manual provides in chapter "Appendix" on page 105 valuable reference data such as piping/wiring diagrams, field settings overview and a checklist to be filled in when you need to escalate an issue to your dealer.

1.4.3. Contact information

This manual has been made with much care and effort. Use it in your daily jobs, as it has been made for you.

Despite our efforts, there is always a chance some cleric or other mistake has been made during the creation of this manual. We kindly ask you to send the found mistakes, or remarks for improvement, to the no-reply email address servicemanual@daikineurope.com.

Part 2. Troubleshooting

This part contains the following chapters:

Error codes check	15
Error based troubleshooting	23
Symptom based troubleshooting	44
Component checklist	45
Other capacity range	61

2.1. Error codes check

2.1.1. Error codes via remote controller

2.1.1.1. Error codes via wired remote controller BRC1E

2.1.1.1.1 How to retrieve error codes

The following message will be displayed on the screen when a malfunction or a warning occurs during operation.

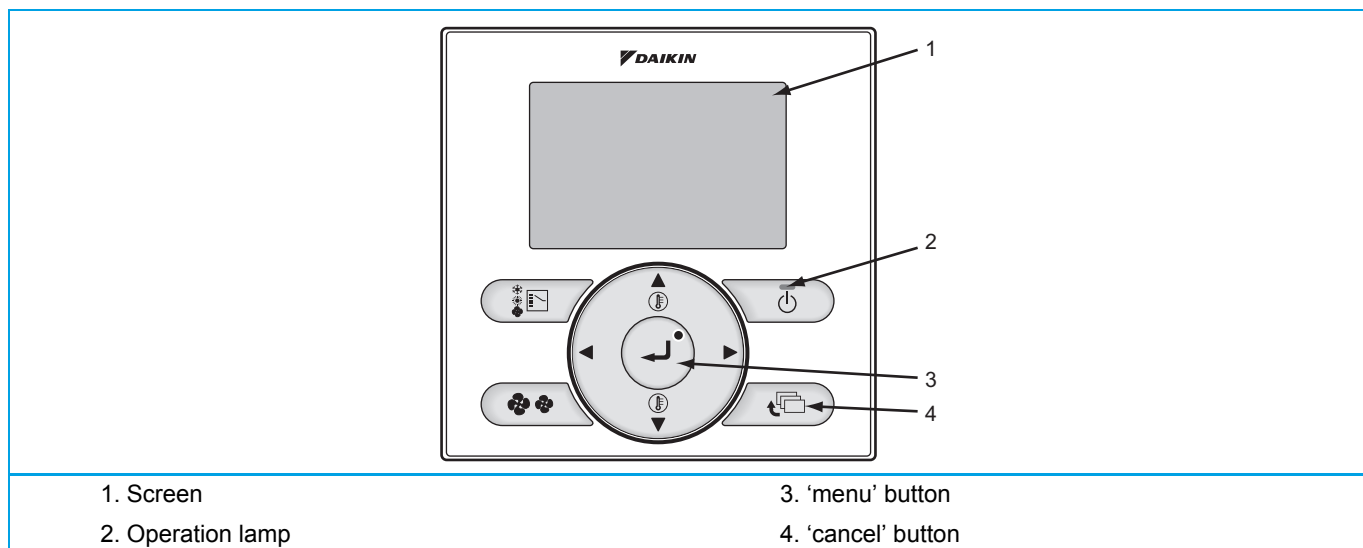

	Operation Status	Display	
Abnormal shut-down	The system stops operating.	The operation lamp (green) starts to blink. The message "Error: Press Menu button" will appear and blink at the bottom of the screen.	
Warning	The system continues its operation.	The operation lamp (green) remains on. The message "Warning: Press Menu button" will appear and blink at the bottom of the screen.	

If an error or warning is present, it will be displayed on the user interface screen: for more information about troubleshooting, refer to "Error based troubleshooting" on page 23.

2.1.1.1.2 How to reset error codes

In "Error based troubleshooting" on page 23 you find a description of how to reset the specific error or warning.

2.1.1.1.3 History of error codes

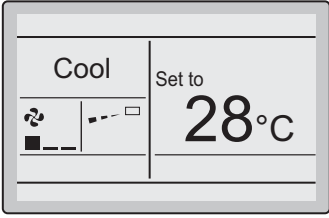
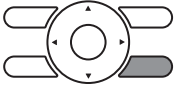
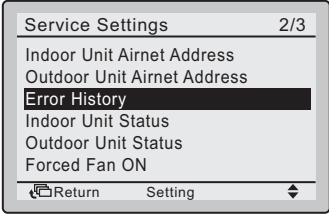
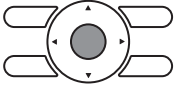
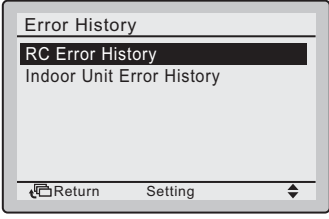
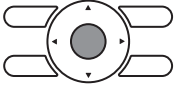
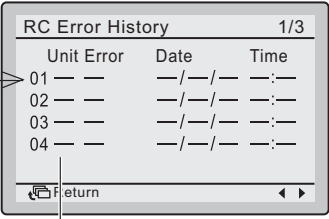
			<Basic screen>	
8-1	Press and hold the Cancel button for 4 seconds or longer in the Basic screen. The Service Settings menu is displayed.	8-1	 <p style="text-align: center;">↓</p>	 <p>Press and hold the Cancel button for 4 seconds or longer while the backlight is lit.</p>
			<Service Settings>	
8-2	Select <i>Error History</i> and press the Menu/Enter button. The Error History menu is displayed	8-2	 <p style="text-align: center;">↓</p>	 <p>Press the Menu/Enter button.</p>
8-3	Select <i>RC Error History</i> and press the Menu/Enter button. The error codes and unit No. can be confirmed in the RC Error History screen.	8-3	 <p style="text-align: center;">↓</p>	 <p>Press the Menu/Enter button.</p>
8-4	In the RC Error History screen the last 10 items are displayed in order.	8-4	 <p style="text-align: center;">↓</p>	<ol style="list-style-type: none"> 1. Latest record 2. Unit no.
8-5	Press the Cancel button in the RC Error History screen 3 times. The Basic screen returns.	8-5		



INFORMATION

The indoor unit error history of each indoor unit can be independently consulted. The last 5 items are displayed in order of appearance.



2.1.1.2. Error codes via wireless remote controller BRC7

2.1.1.2.1 How to retrieve error codes

If the unit stops due to an error, the operation indicating LED on the indoor unit flashes.

The error code can be determined through the wireless remote controller by following the procedure described below.

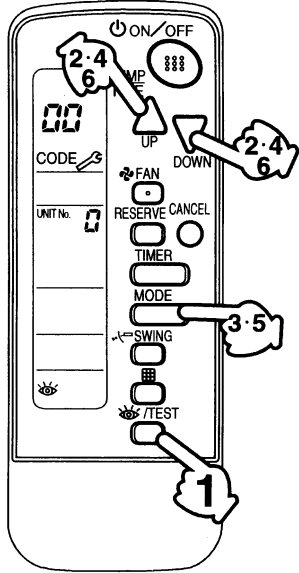
If an error or warning is present, it will be displayed on the screen: for more information about troubleshooting, refer to "Error based troubleshooting" on page 23.

<p>1</p>	<p>Press the INSPECTION/TEST button to select "inspection". The equipment enters the inspection mode. The "Unit" indication is displayed and the Unit No. display shows flashing "0" indication.</p>	
<p>2</p>	<p>Set the Unit No. Press the UP or DOWN button and change the Unit No. display until the buzzer (*1) is generated from the indoor unit. *1 Number of beeps 3 short beeps: Conduct all of the following operations. 1 short beep: Conduct steps 3 and 4. Continue the operation in step 4 until a buzzer remains ON. The continuous buzzer indicates that the error code is confirmed. Continuous beep: No abnormality.</p>	
<p>3</p>	<p>Press the MODE selector button. The left "0" (upper digit) indication of the error code flashes.</p>	
<p>4</p>	<p>Error code upper digit diagnosis Press the UP or DOWN button and change the error code upper digit until the error code matching buzzer (*2) is generated. • The upper digit of the code changes as shown below when the UP and DOWN buttons are pressed.</p> <div style="text-align: center;">  <p>⇨ "UP" button ⇩ "DOWN" button</p> </div> <p>*2 Number of beeps Continuous beep: Both upper and lower digits matched. (Error code confirmed) 2 short beeps: Upper digit matched. 1 short beep: Lower digit matched.</p>	
<p>5</p>	<p>Press the MODE selector button. The right "0" (lower digit) indication of the error code flashes.</p>	
<p>6</p>	<p>Error code lower digit diagnosis Press the UP or DOWN button and change the error code lower digit until the continuous error code matching buzzer (*2) is generated. • The lower digit of the code changes as shown below when the UP and DOWN buttons are pressed.</p> <div style="text-align: center;">  <p>⇨ "UP" button ⇩ "DOWN" button</p> </div>	

Normal status

Enters inspection mode from normal status when the INSPECTION/ TEST button is pressed.

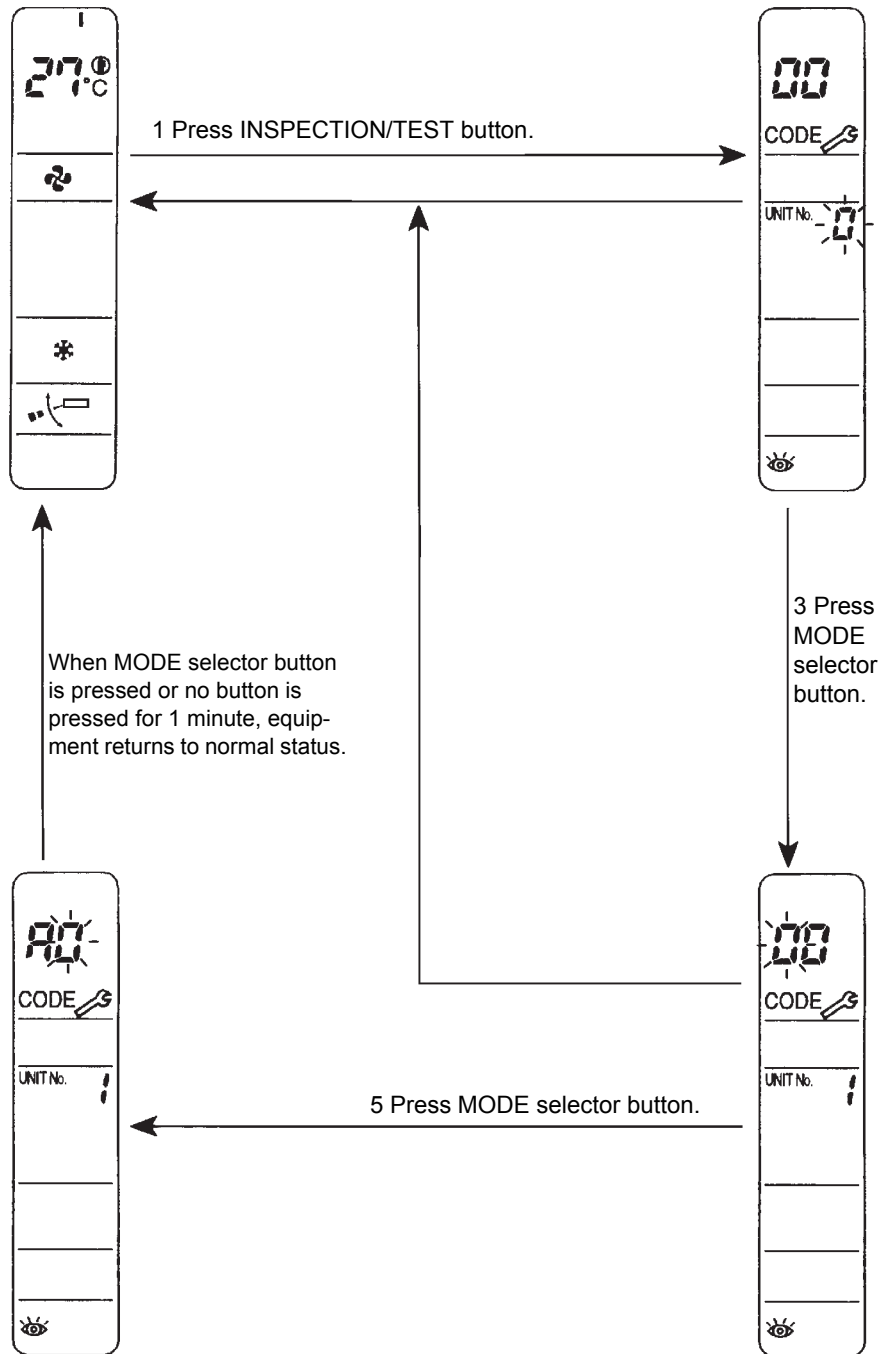

2.1.1.2.2 How to reset error codes

In "Error based troubleshooting" on page 23 you find a description of how to reset the specific error or warning.

2.1.1.3. Error codes via indoor remote controller BRC1H

2.1.1.3.1 How to retrieve error codes

To indicate a system error, the controller displays  on the message zone (a) of the home screen.

1. Press the middle button  (b) to enter the main menu from the home screen; an error screen (c) is displayed.

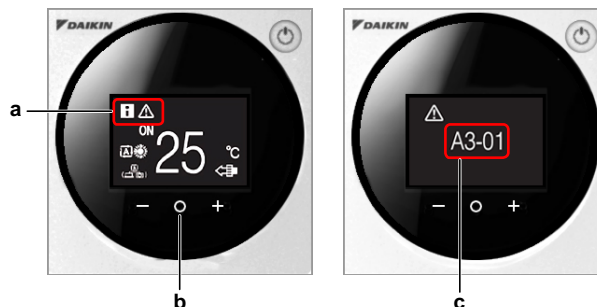

2. Press the middle button  (b) to return to the home screen.

Active error codes are also available through the Madoka Assistant for BRC1H.

The active error (d) is shown on the home screen (e).

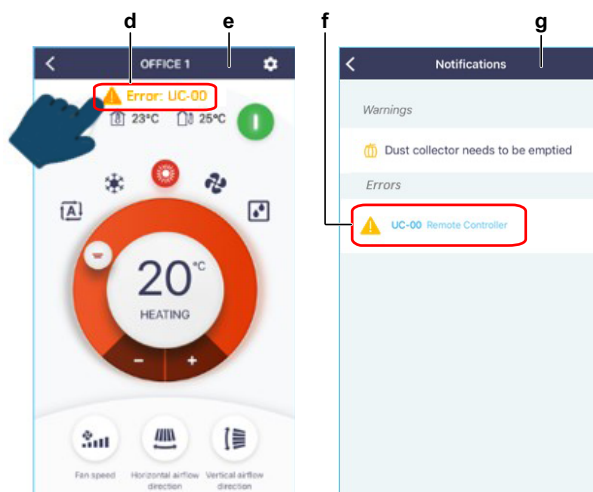

3. Tap the error message (d); the details of the error(s) (f) are shown on the notifications screen (g).

2.1.1.3.2 How to reset error codes

In ["Error based troubleshooting" on page 23](#) you find a description of how to reset the specific error or warning.

2.1.1.3.3 History of error codes

1. Tap the settings icon (h); the “Unit settings” screen appears.

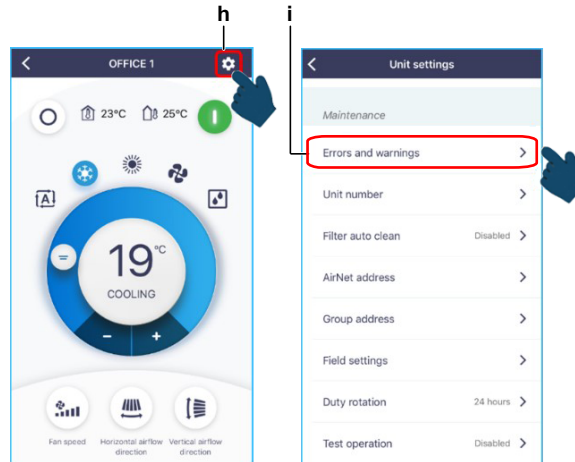

2. Choose “Errors and warnings” (i); the “Errors and warnings” screen appears.

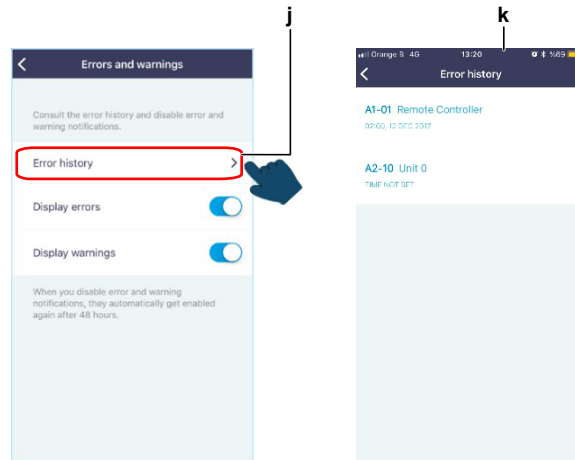

3. Choose “Error history” (j); the “Error history” screen (k) appears.

For more details on the Madoka Assistant please refer to the BRC1H training course material which is available on the Daikin Business Portal.

2.1.2. Error codes via outdoor unit PCB

2.1.2.1. How to retrieve error codes

Error code descriptions are accessible on “Mode 1: Monitor Mode”.

The table below shows which setting shows the error codes that led to an outdoor unit forced stop.

When an error is generated, the unit performs a forced off until the error is retrieved. The current error code will be shown on the 7-segment display. You can also access the error history on “Mode 1: Monitor Mode”.

Mode	Setting	Description
Mode 1: Monitor mode	4	Last error code
	5	2nd last error code
	6	3rd last error code

Please follow the procedure described below to access the regarding error code for outdoor unit forced stop and/or retry description:

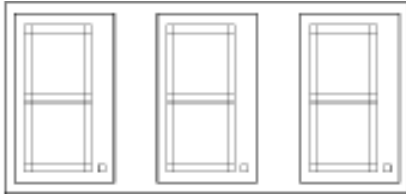
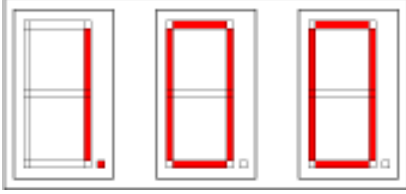
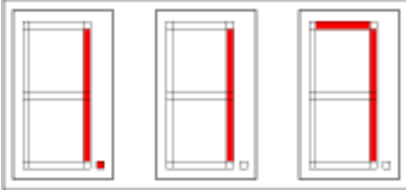
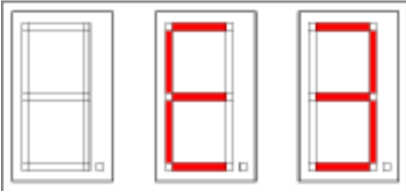
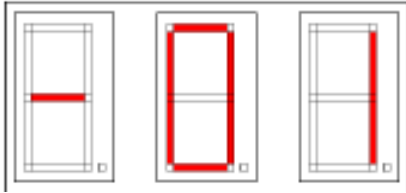
Action	Result	Display
Make sure the 7-segment display indication is as during normal operation.		
To enter “Mode 1”, push the (BS1) button one time.	Mode 1 is accessed.	
Push the (BS2) button as many times as the setting you want to go to.	The setting is accessed (e.g. 17, Error code last forced off).	
Press the RETURN (BS3) Button.	Malfunction/Retry item will appear on display.	
Press the SET (BS2) Button.	Detailed Malfunction/Retry sub-code will appear on display.	

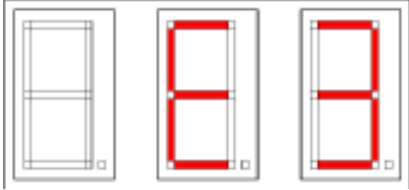
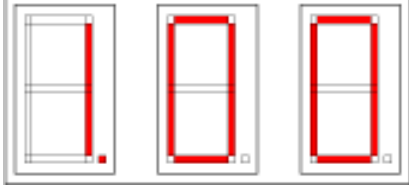
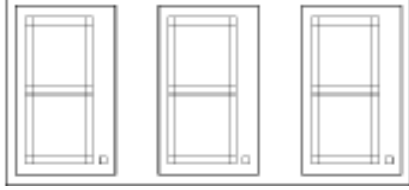
Action	Result	Display
Press SET (BS2) once again to return to main Malfunction/Retry display.	Main Malfunction/Retry item will appear on display.	
Press the RETURN (BS3) Button to return to Home Screen for "Monitoring Mode".	Home Screen for "Monitoring Mode" will appear on display.	
Press the MODE (BS1) Button to return to "Normal Mode".	Back in normal mode.	

2.2. Error based troubleshooting

Overview of error codes:

Indoor unit	24
“A0-11” – Detection of refrigerant leak	24
“A1-01” – Indoor unit PCB abnormality	24
“A3-00” – Drain water level system abnormality.....	24
“A6-00” – Indoor unit fan motor abnormality.....	25
“AJ-00” – Capacity setting abnormality	25
“C1-00” – Transmission error (indoor & adapter PCB).....	26
“C4-00” – Liquid pipe thermistor for heat exchanger abnormality	26
“C5-00” – Intermediate heat exchanger thermistor abnormality.....	26
“C9-00” – Suction air thermistor abnormality.....	27
“CC-00” – Humidity sensor system abnormality	27
“CH-01” – Refrigerant leakage sensor abnormality.....	28
“CJ-00” – Remote controller thermistor abnormality	28
Outdoor unit.....	29
“E1-00” – Outdoor unit PCB abnormality.....	29
“E3-00” – Discharge pressure abnormality.....	29
“E4-00” – Suction pressure abnormality	30
“E5-00” – Compressor motor lock or overheated	30
“E7-00” – Fan motor abnormality	31
“E9-00” – Electronic expansion valve abnormality	31
“F3-00” – Discharge pipe temperature abnormality.....	32
“H3-00” – High pressure switch abnormality	33
“H4-00” – Low pressure switch abnormality	33
“H9-00” – Outdoor air temperature thermistor abnormality	33
“J3-00” – Discharge pipe thermistor abnormality	34
“J5-00” – Suction pipe thermistor abnormality.....	34
“J6-00” – Outdoor heat exchanger thermistor abnormality.....	34
“J7-00” – Intermediate heat exchanger thermistor abnormality.....	35
“J8-00” – Liquid pipe thermistor abnormality	35
“L1-00” – Outdoor main PCB abnormality	35
“L5-00” – Inverter instantaneous overcurrent (AC output).....	36
“L8-00” – Electronic thermal overload	37
“L9-00” – Stall prevention time lag	37
“LC-00” – Transmission system abnormality.....	38
“P1-00” – Open phase or power supply voltage imbalance	38
“P4-00” – Radiating fin temperature sensor abnormality.....	39
“PJ-00” – Capacity setting abnormality	39
System	40
“U0-00” – Refrigerant shortage	40
“U1-00” – Reverse phase or open phase.....	40
“U2-00” – Power supply abnormality or instantaneous power failure.....	41
“U4-00” – Transmission abnormality between indoor unit and outdoor unit.....	41
“UA-00” – Improper combination of indoor unit and outdoor unit	42
“UF-00” – Wiring and piping mismatch.....	42
Others	43

2.2.1. Indoor unit

2.2.1.1. "A0-11" – Detection of refrigerant leak

Trigger	Effect	Reset
Detect gas leakage (R32 or other gases).	Outdoor unit stops running. Indoor fan starts in fan only. Blinking LED.	Auto reset indoor unit after 320s no gas detection.

Possible cause	Check	Corrective action
Refrigerant leakage.	Check for refrigerant leak indoor unit.	Repair leak and recharge refrigerant if required.
No refrigerant leakage.	Check possible other gasses: hairspray, alcohol, cleaning agent,	Ventilate the room.

2.2.1.2. "A1-01" – Indoor unit PCB abnormality

Trigger	Effect	Reset
EEPROM data is not received correctly.	Unit will stop operating.	Power reset via outdoor unit.

Possible cause	Check	Corrective action
Indoor Unit - Electrical components		
Faulty indoor PCB.	Check if error still occurs after turning off power and turning it back on again. Check if the indoor PCB receives power. Check if the HAP LED is blinking in regular intervals. Check if the correct spare part is installed. Check the wiring to indoor PCB.	Adjust power to the indoor PCB. Replace indoor PCB when HAP LED is not blinking in regular intervals. Install correct spare part or update indoor PCB. Adjust wiring to indoor PCB when required.

2.2.1.3. "A3-00" – Drain water level system abnormality

Trigger	Effect	Reset
Drain water level reaches its upper limit and float switch turns OFF.	Unit will stop operating.	Automatic reset.

Possible cause	Check	Corrective action
Defective drain pump.	Check drain pump.	Replace drain pump when required.
Improper drain piping work or clogging.	Check if drain piping is executed correctly. Check if drain piping is clogged.	Correct or clean drain piping when required.
Defective flow switch.	Check flow switch.	Replace flow switch when required.
(for optional drain pump kit) Defective short circuit connector X15A.	Check if connector is firmly connected. Check the continuity of the short circuit connector.	Connect the short circuit connector. Replace the short circuit connector when required. Replace the indoor PCB when required.

Possible cause	Check	Corrective action
Faulty indoor PCB.	Check if error still occurs after turning off power and turning it back on again. Check if the indoor PCB receives power. Check if the HAP LED is blinking in regular intervals. Check if the correct spare part is installed. Check the wiring to indoor PCB.	Adjust power to the indoor PCB. Replace indoor PCB when HAP LED is not blinking in regular intervals. Install correct spare part or update indoor PCB. Adjust wiring to indoor PCB when required.

2.2.1.4. "A6-00" – Indoor unit fan motor abnormality

Trigger	Effect	Reset
The rotation speed of the fan motor is not detected while the output voltage to the fan is at its maximum.	Unit will stop operating.	Power reset via outdoor unit.

Possible cause	Check	Corrective action
Faulty indoor PCB.	Check if error still occurs after turning off power and turning it back on again. Check if the indoor PCB receives power. Check if the HAP LED is blinking in regular intervals. Check if the correct spare part is installed. Check the wiring to indoor PCB.	Adjust power to the indoor PCB. Replace indoor PCB when HAP LED is not blinking in regular intervals. Install correct spare part or update indoor PCB. Adjust wiring to indoor PCB when required.
Faulty indoor fan motor.	Check the fan motor. Check fan motor connections and wiring.	Replace fan motor when required. Adjust wiring when required.
Indoor fan motor locked.	Switch of the power. Turn fan manually.	Replace fan motor when the fan does not turn smoothly.

2.2.1.5. "AJ-00" – Capacity setting abnormality

Trigger	Effect	Reset
The capacity setting adaptor is not connected or not recognised by the indoor PCB.	Unit will stop operating.	Power reset via outdoor unit.

Possible cause	Check	Corrective action
Faulty indoor PCB.	Check if error still occurs after turning off power and turning it back on again. Check if the indoor PCB receives power. Check if the HAP LED is blinking in regular intervals. Check if the correct spare part is installed. Check the wiring to indoor PCB.	Adjust power to the indoor PCB. Replace indoor PCB when HAP LED is not blinking in regular intervals. Install correct spare part or update indoor PCB. Adjust wiring to indoor PCB when required.
Faulty capacity adapter on indoor PCB (in case of spare part PCB).	Check if the correct adapter is installed. Check if the correct spare part is installed.	Adjust capacity adapter when required.

2.2.1.6. “C1-00” – Transmission error (indoor & adaptor PCB)

Trigger	Effect	Reset
When normal transmission between indoor unit PCB & adaptor PCB is not conducted for a certain duration (15 seconds or more).	Unit will stop operating.	Power reset via outdoor unit.

Possible cause	Check	Corrective action
Faulty adaptor PCB.	Check if the adaptor PCB is installed. Check if the connector X8A on the adaptor PCB is not circuited. Check the wire harness.	Adjust when required.
Faulty indoor PCB.	Check if error still occurs after turning off power and turning it back on again. Check if the indoor PCB receives power. Check if the HAP LED is blinking in regular intervals. Check if the correct spare part is installed. Check the wiring to indoor PCB.	Adjust power to the indoor PCB. Replace indoor PCB when HAP LED is not blinking in regular intervals. Install correct spare part or update indoor PCB. Adjust wiring to indoor PCB when required.
External factory (e.g. electrical noise) (cause when error is reset after power reset, and error happens again after a while).	Check for source which could cause electrical interference.	Avoid electrical interference.
Internal wiring is not OK.	Check if wiring between PCB's is correct (refer to wiring diagram).	Correct wiring.

2.2.1.7. “C4-00” – Liquid pipe thermistor for heat exchanger abnormality

Trigger	Effect	Reset
Thermistor input is > 4.96 V or < 0.04 V during compressor operation.	Unit will stop operating.	Power reset via outdoor unit.

Possible cause	Check	Corrective action
Faulty liquid pipe thermistor.	Check liquid pipe thermistor.	Replace liquid pipe thermistor when required.
Faulty indoor unit main PCB.	Check if error still occurs after turning off power and turning it back on again. Check if the indoor PCB receives power. Check if the HAP LED is blinking in regular intervals. Check if the correct spare part is installed. Check the wiring to indoor PCB.	Adjust the power to the indoor main PCB. Replace indoor main PCB when HAP LED is not blinking in regular intervals.

2.2.1.8. “C5-00” – Intermediate heat exchanger thermistor abnormality

Trigger	Effect	Reset
Resistance value is out of range. T measured < -43.6°C or > 90°C.	Unit will stop operating.	Automatic reset when resistance is within range.

Possible cause	Check	Corrective action
Faulty Intermediate Heat Exchanger thermistor.	Check intermediate heat exchanger thermistor (see "Refrigerant thermistors" on page 58).	Replace intermediate heat exchanger thermistor when required.
Faulty indoor PCB.	Check if error still occurs after turning off power and turning it back on again. Check if the indoor PCB receives power. Check if the HAP LED is blinking in regular intervals. Check if the correct spare part is installed. Check the wiring to indoor PCB.	Adjust power to the indoor PCB. Replace indoor PCB when HAP LED is not blinking in regular intervals. Install correct spare part or update indoor PCB. Adjust wiring to indoor PCB when required.

2.2.1.9. "C9-00" – Suction air thermistor abnormality

Trigger	Effect	Reset
Resistance value is out of range. T measured < -43.6°C or > 90°C.	Unit will stop operating.	Automatic reset when resistance is within range.

Possible cause	Check	Corrective action
Faulty suction air thermistor.	Check suction air thermistor.	Replace suction air thermistor when required.
Faulty indoor PCB.	Check if error still occurs after turning off power and turning it back on again. Check if the indoor PCB receives power. Check if the HAP LED is blinking in regular intervals. Check if the correct spare part is installed. Check the wiring to indoor PCB.	Adjust power to the indoor PCB. Replace indoor PCB when HAP LED is not blinking in regular intervals. Install correct spare part or update indoor PCB. Adjust wiring to indoor PCB when required.

2.2.1.10. "CC-00" – Humidity sensor system abnormality

Trigger	Effect	Reset
The humidity sensor is disconnected or short circuit when the unit is running.	Unit will not stop operating.	Manual reset via user interface.

Possible cause	Check	Corrective action
Faulty humidity sensor.	Check good connection to indoor PCB.	Replace the humidity sensor when required.
External factory (e.g. electrical noise) (cause when error is reset after power reset, and error happens again after a while).	Check for source which could cause electrical interference.	Avoid electrical interference.

2.2.1.11. "CH-01" – Refrigerant leakage sensor abnormality

Trigger	Effect	Reset
Sensor error.	Unit will stop operating. Buzzer beeps in some of the remote controllers. Blinking LED.	Power reset via outdoor unit.

Possible cause	Check	Corrective action
Sensor connection is not OK.	Check if connection and wiring of sensor to PCB is OK.	Correct wiring connection or repair wiring.
Sensor error.	Outdoor unit off and indoor fan unit will operate for 250 min.	Replace sensor and power reset outdoor unit (if needed: pump down and remove field piping).

2.2.1.12. "CJ-00" – Remote controller thermistor abnormality

Trigger	Effect	Reset
Disconnected or short circuit remote controller thermistor.	Unit will not stop operating.	Automatic reset.

Possible cause	Check	Corrective action
Indoor Unit - Electrical components		
Faulty remote controller thermistor.	Erase the error record from the remote controller.	Push the ON/OFF button on the remote controller for 5 seconds in the check mode. Replace the remote controller.
External factory (e.g. electrical noise) (cause when error is reset after power reset, and error happens again after a while).	Check for source which could cause electrical interference.	Avoid electrical interference.

2.2.2. Outdoor unit

2.2.2.1. "E1-00" – Outdoor unit PCB abnormality

Trigger	Effect	Reset
Outdoor main PCB detects that EEPROM is abnormal.	Unit will stop operating.	Manual reset via user interface. Power reset via outdoor unit.

Possible cause	Check	Corrective action
Faulty outdoor unit main PCB.	Check if the HAP LED is blinking in regular intervals. Check if the correct spare part is installed. Check if the outdoor main PCB receives power.	Restore the power to the outdoor main PCB. Replace outdoor main PCB when HAP LED is not blinking in regular intervals.
Faulty capacity adapter on outdoor main PCB installed.	Check if the correct capacity adapter is used.	Replace capacity adapter when required.
External factor (e.g. electrical noise) (cause when error is reset after power reset, and error happens again after a while).	Check for source which could cause electrical interference.	Avoid electrical interference.
Faulty outdoor fan motor.	Check the fan motor. Check fan motor connections and wiring.	Replace fan motor when required. Adjust wiring when required.
Faulty or disturbance of the power supply (imbalance > 10%). Power drop. Short circuit.	Check if the power supply is conform with regulations. No fluctuations in frequency.	Adjust power supply when required. Power reset via outdoor unit.

2.2.2.2. "E3-00" – Discharge pressure abnormality

Trigger	Effect	Reset
High pressure switch opens due to measure pressure > 41.7 bar.	Unit will stop operating.	Manual reset via user interface.
High pressure control (measure pressure > 38 bar) occurs 16 times within 300 minutes.		

Possible cause	Check	Corrective action
Faulty high pressure switch.	Check high pressure switch.	Replace high pressure switch.
Faulty outdoor unit main PCB.	Check if the HAP LED is blinking in regular intervals. Check if the correct spare part is installed. Check if the outdoor main PCB receives power.	Adjust the power to the outdoor main PCB. Replace outdoor main PCB when HAP LED is not blinking in regular intervals.
Faulty capacity adapter on outdoor PCB.	Check if the correct adapter is installed. Check if the correct spare part is installed.	Adjust capacity adapter when required.
Refrigerant overcharge.	Check for refrigerant overcharge. Refer to the nameplate for the correct charge.	Charge the correct refrigerant amount when required.
Humidity in refrigerant (ice formation in expansion valve).	Check for humidity in the refrigerant.	In case of suspicion of humidity, recover, vacuum and recharge with virgin refrigerant.
Non condensables in refrigerant.	Check for non condensables in refrigerant.	In case of suspicion of non condensables, recover, vacuum and recharge with virgin refrigerant.

Possible cause	Check	Corrective action
Refrigerant is contaminated.	Check for non condensables in refrigerant.	In case of suspicion of non condensables. Recover, vacuum and recharge refrigerant.
Stop valve is closed.	Check if stop valve is open.	Open stop valve when required.
Faulty outdoor fan motor.	Check the fan motor. Check fan motor connections and wiring.	Replace fan motor when required. Adjust wiring when required.

2.2.2.3. "E4-00" – Suction pressure abnormality

Trigger	Effect	Reset
When refrigerant pressure is below 1,2 bar for 5 minutes.	Unit will stop operating.	Manual reset via user interface.

Possible cause	Check	Corrective action
Faulty outdoor unit main PCB.	Check if the HAP LED is blinking in regular intervals. Check if the correct spare part is installed. Check if the outdoor main PCB receives power.	Adjust the power to the outdoor main PCB. Replace outdoor main PCB when HAP LED is not blinking in regular intervals (see "Replacing main PCB" on page 94).
Bad contact through pressure sensor cable.	Check if pressure sensor connector is properly connected to the outdoor PCB board.	Connect or replace sensor cable when required.
Faulty capacity adapter on outdoor PCB.	Check if the correct adapter is installed. Check if the correct spare part is installed.	Adjust capacity adapter when required.
Stop valve is closed.	Check if stop valve is open.	Open stop valve when required.
Abnormal drop of low pressure, caused by inadequate refrigerant, abnormal refrigerant piping system or faulty electronic expansion valve.	Check for possible blockage. (Blockages can be checked by measuring the refrigerant/pipe temperature. Sudden drop in temperature could indicate a blockage (remark: this is not valid for the expansion valve.))	Replace the blocked part.

2.2.2.4. "E5-00" – Compressor motor lock or overheated

Trigger	Effect	Reset
Compressor overload is detected.	Unit will stop operating.	Automatic reset if the unit runs for 60 seconds without error.

Possible cause	Check	Corrective action
Faulty discharge pipe thermistor.	Check discharge pipe thermistor.	Replace discharge pipe thermistor when required.
Faulty outdoor fan motor.	Check the fan motor. Check fan motor connections and wiring.	Replace fan motor when required. Adjust wiring when required.
Faulty overload protection.	Check the overload protection. Check the overload protection connections and wiring.	Replace the overload protection when required. Adjust wiring when required.
Faulty expansion valve.	Check the expansion valve.	Replace the expansion valve body or motor when required.
Faulty 4-way valve.	Check the 4-way valve.	Replace the 4-way valve coil or body when required.

Possible cause	Check	Corrective action
Faulty outdoor unit main PCB.	Check if the HAP LED is blinking in regular intervals. Check if the correct spare part is installed. Check if the outdoor main PCB receives power.	Restore the power to the outdoor main PCB. Replace outdoor main PCB when HAP LED is not blinking in regular intervals.
Faulty power module = faulty outdoor inverter PCB.	Check outdoor inverter PCB. Check if the HAP LED is blinking in regular intervals. Check if the correct spare part is installed.	Restore the power to the outdoor inverter PCB. Replace the outdoor inverter PCB when required.
Refrigerant shortage.	Check for refrigerant shortage. Refer to the nameplate for the correct charge.	Charge the correct refrigerant amount when required.
Humidity in refrigerant (ice formation in expansion valve).	Check for humidity in the refrigerant.	In case of suspicion of humidity, recover, vacuum and recharge with virgin refrigerant.
Non condensables in refrigerant.	Check for non condensables in refrigerant.	In case of suspicion of non condensables, recover, vacuum and recharge with virgin refrigerant.
Stop valve is closed.	Check stop valve.	Open stop valve when required.

2.2.2.5. "E7-00" – Fan motor abnormality

Trigger	Effect	Reset
Fan does not start in about 15~30 seconds = fan motor lock. It can occur that E7-00 error is triggered even when the fan motor is running caused by a faulty hall signal.	Unit will not stop operating.	Automatic reset after a continuous run.
	Unit will stop operating.	Manual reset via user interface.

Possible cause	Check	Corrective action
Faulty outdoor fan motor.	Check the fan motor. Check fan motor connections and wiring.	Replace fan motor when required. Adjust wiring when required.
Faulty outdoor inverter PCB.	Check outdoor inverter PCB. Check if the HAP LED is blinking in regular intervals. Check if the correct spare part is installed.	Restore the power to the outdoor inverter PCB. Replace the outdoor inverter PCB when required.
Blown fuse.	Check the fuse on the outdoor unit PCB's.	Replace fuse when required.

2.2.2.6. "E9-00" – Electronic expansion valve abnormality

Trigger	Effect	Reset
1. No continuity of expansion valve. 2. Minimum expansion valve opening and suction superheat < A K and discharge superheat < B K.	Unit will stop operating.	Manual reset via user interface. Power reset via outdoor unit.

Possible cause	Check	Corrective action
Wet operation.	Check for wet operation. (Wet operation can be detected by checking the suction superheat. If the suction superheat is 0°C then liquid refrigerant is returned to the compressor.)	In case wet operation was detected, confirm the cause: <ul style="list-style-type: none"> Refrigerant overcharge. Faulty expansion valve.

Possible cause	Check	Corrective action
Faulty outdoor unit main PCB.	Check if the HAP LED is blinking in regular intervals. Check if the correct spare part is installed. Check if the outdoor main PCB receives power.	Adjust the power to the outdoor main PCB. Replace outdoor main PCB when HAP LED is not blinking in regular intervals.
Faulty thermistor.	Check thermistor.	Replace thermistor when required.
Faulty or disturbance of the power supply (imbalance >10%). Power drop. Short circuit.	Check if the power supply is conform with regulations. No fluctuations in frequency.	Adjust power supply when required. Power reset via outdoor unit.
Faulty expansion valve.	Check the expansion valve.	Replace the expansion valve body or motor when required.
Faulty capacity adapter on outdoor PCB.	Check if the correct adapter is installed. Check if the correct spare part is installed.	Adjust capacity adapter when required.
External factory (e.g. electrical noise) (cause when error is reset after power reset, and error happens again after a while).	Check for source which could cause electrical interference.	Avoid electrical interference.

2.2.2.7. "F3-00" – Discharge pipe temperature abnormality

Trigger	Effect	Reset
Discharge temperature is too high: <ul style="list-style-type: none"> If the discharge temperature detected is above A°C, 10 times within 200 min. If within 200 min the discharge temperature detected is 10 times above B°C for 15 min. 	Unit will not stop operating.	Automatic reset when temperature drops below C°C.
	Unit will stop operating.	Manual reset via remote controller.

Possible cause	Check	Corrective action
Refrigerant shortage.	Check for refrigerant shortage. Refer to the nameplate for the correct charge.	Charge the correct refrigerant amount when required.
Humidity in refrigerant (ice formation in expansion valve).	Check for humidity in the refrigerant.	In case of suspicion of humidity, recover, vacuum and recharge with virgin refrigerant.
Non condensables in refrigerant.	Check for non condensables in refrigerant.	In case of suspicion of non condensables, recover, vacuum and recharge with virgin refrigerant.
Stop valve is closed.	Check if stop valve is open.	Open stop valve when required.
Faulty 4-way valve.	Check the 4-way valve.	Replace the 4-way valve coil or body when required.
Faulty expansion valve.	Check the expansion valve.	Replace the expansion valve body or motor when required.
Faulty outdoor unit main PCB.	Check if the HAP LED is blinking in regular intervals. Check if the correct spare part is installed. Check if the outdoor main PCB receives power.	Restore the power to the outdoor main PCB. Replace outdoor main PCB when HAP LED is not blinking in regular intervals.
Faulty discharge thermistor.	Check discharge thermistor.	Replace discharge thermistor when required.
Faulty heat exchanger thermistor.	Check heat exchanger thermistor.	Replace heat exchanger thermistor when required.
Faulty outdoor temperature thermistor.	Check outdoor temperature thermistor.	Replace outdoor temperature thermistor when required.

2.2.2.8. “H3-00” – High pressure switch abnormality

Trigger	Effect	Reset
High pressure switch is activated when compressor is off.	Unit will stop operating.	Manual reset via user interface.

Possible cause	Check	Corrective action
Stop valve is closed.	Check if stop valve is open.	Open stop valve when required.
Faulty outdoor unit main PCB.	Check if the HAP LED is blinking in regular intervals. Check if the correct spare part is installed. Check if the outdoor main PCB receives power.	Adjust the power to the outdoor main PCB. Replace outdoor main PCB when HAP LED is not blinking in regular intervals.
Faulty outdoor inverter PCB.	Check outdoor inverter PCB. Check if the alive led is blinking in regular intervals. Check if the correct spare part is installed.	Adjust the power to the outdoor inverter PCB. Replace outdoor inverter PCB.
Faulty or disturbance of the power supply (imbalance > 10%). Power drop. Short circuit.	Check if the power supply is conform with regulations. No fluctuations in frequency.	Adjust power supply when required. Power reset via outdoor unit.
Faulty high pressure switch.	Check high pressure switch.	Replace the high pressure switch.
Faulty capacity adapter on outdoor PCB.	Check if the correct adapter is installed. Check if the correct spare part is installed.	Adjust capacity adapter when required.

2.2.2.9. “H4-00” – Low pressure switch abnormality

Trigger	Effect	Reset
When there is no continuity in the low pressure switch during compressor start.	Unit will stop operating.	Automatic reset.

Possible cause	Check	Corrective action
Refrigerant shortage.	Check for refrigerant shortage. Refer to the nameplate for the correct charge.	Charge the correct refrigerant amount when required.
Stop valve is closed.	Check if stop valve is open.	Open stop valve when required.
Faulty outdoor unit main PCB.	Check if the HAP LED is blinking in regular intervals. Check if the correct spare part is installed. Check if the outdoor main PCB receives power.	Adjust the power to the outdoor main PCB. Replace outdoor main PCB when HAP LED is not blinking in regular intervals.
Faulty expansion valve.	Check the expansion valve.	Replace the expansion valve body or motor when required.
Faulty low pressure switch.	Check low pressure switch.	Replace low pressure switch.

2.2.2.10. “H9-00” – Outdoor air temperature thermistor abnormality

Trigger	Effect	Reset
Thermistor input voltage is > 4.96 V or < 0.04 V when power is on.	Unit will stop operating.	Manual reset via user interface.

Possible cause	Check	Corrective action
Faulty outdoor air temperature thermistor.	Check outdoor temperature thermistor.	Replace outdoor temperature thermistor when required.
Faulty outdoor unit main PCB.	Check if the HAP LED is blinking in regular intervals. Check if the correct spare part is installed. Check if the outdoor main PCB receives power.	Restore the power to the outdoor main PCB. Replace outdoor main PCB when HAP LED is not blinking in regular intervals.

2.2.2.11. "J3-00" – Discharge pipe thermistor abnormality

Trigger	Effect	Reset
Thermistor input voltage is > 4.96 V or < 0.04 V when power is on.	Unit will stop operating.	Manual reset via user interface.
Discharge pipe temperature is lower than the heat exchanger temperature.		

Possible cause	Check	Corrective action
Faulty discharge pipe thermistor.	Check discharge pipe thermistor.	Replace discharge pipe thermistor when required.
Faulty outdoor unit main PCB.	Check if the HAP LED is blinking in regular intervals. Check if the correct spare part is installed. Check if the outdoor main PCB receives power.	Restore the power to the outdoor main PCB. Replace outdoor main PCB when HAP LED is not blinking in regular intervals.

2.2.2.12. "J5-00" – Suction pipe thermistor abnormality

Trigger	Effect	Reset
Suction pipe thermistor detects an abnormal value (open or short circuit).	Unit will stop operating.	Automatic reset.

Possible cause	Check	Corrective action
Faulty outdoor unit main PCB.	Check if the HAP LED is blinking in regular intervals. Check if the correct spare part is installed. Check if the outdoor main PCB receives power.	Adjust the power to the outdoor main PCB. Replace outdoor main PCB when HAP LED is not blinking in regular intervals.
Faulty suction pipe thermistor.	Check suction pipe thermistor.	Replace suction pipe thermistor when required.
Faulty capacity adapter on outdoor PCB.	Check if the correct adapter is installed. Check if the correct spare part is installed.	Adjust capacity adapter when required.

2.2.2.13. "J6-00" – Outdoor heat exchanger thermistor abnormality

Trigger	Effect	Reset
Thermistor input voltage is > 4.96 V or < 0.04 V when power is on.	Unit will stop operating.	Manual reset via user interface.

Possible cause	Check	Corrective action
Faulty heat exchanger thermistor.	Check heat exchanger thermistor.	Replace heat exchanger thermistor when required.
Faulty outdoor unit main PCB.	Check if the HAP LED is blinking in regular intervals. Check if the correct spare part is installed. Check if the outdoor main PCB receives power.	Restore the power to the outdoor main PCB. Replace outdoor main PCB when HAP LED is not blinking in regular intervals.

2.2.2.14. "J7-00" – Intermediate heat exchanger thermistor abnormality

Trigger	Effect	Reset
Intermediate heat exchanger thermistor R5T detects an abnormal value (open or short circuit).	Unit will stop operating.	Automatic reset.

Possible cause	Check	Corrective action
Faulty outdoor unit main PCB.	Check if the HAP LED is blinking in regular intervals. Check if the correct spare part is installed. Check if the outdoor main PCB receives power.	Adjust the power to the outdoor main PCB. Replace outdoor main PCB when HAP LED is not blinking in regular intervals.
Faulty intermediate heat exchanger thermistor.	Check intermediate heat exchanger thermistor.	Replace intermediate heat exchanger thermistor when required.
Faulty capacity adapter on outdoor PCB.	Check if the correct adapter is installed. Check if the correct spare part is installed.	Adjust capacity adapter when required.

2.2.2.15. "J8-00" – Liquid pipe thermistor abnormality

Trigger	Effect	Reset
Liquid pipe thermistor detects an abnormal value (open or short circuit).	Unit will stop operating.	Automatic reset.

Possible cause	Check	Corrective action
Faulty outdoor unit main PCB.	Check if the HAP LED is blinking in regular intervals. Check if the correct spare part is installed. Check if the outdoor main PCB receives power.	Adjust the power to the outdoor main PCB. Replace outdoor main PCB when HAP LED is not blinking in regular intervals.
Faulty liquid pipe thermistor.	Check liquid pipe thermistor.	Replace liquid pipe thermistor when required.
Faulty capacity adapter on outdoor PCB.	Check if the correct adapter is installed. Check if the correct spare part is installed.	Adjust capacity adapter when required.

2.2.2.16. "L1-00" – Outdoor main PCB abnormality

Trigger	Effect	Reset
Outdoor main PCB detects current/voltage errors.	Unit will stop operating.	Manual reset via user interface. Power reset via outdoor unit.

Possible cause	Check	Corrective action
Blown fuse.	Check fuse on outdoor main PCB.	Replace fuse if blown.
Faulty outdoor unit main PCB.	Check if the HAP LED is blinking in regular intervals. Check if the correct spare part is installed. Check if the outdoor main PCB receives power.	Adjust the power to the outdoor main PCB. Replace outdoor main PCB when HAP LED is not blinking in regular intervals.
Faulty outdoor inverter PCB.	Check outdoor inverter PCB. Check if the alive led is blinking in regular intervals. Check if the correct spare part is installed.	Adjust the power to the outdoor inverter PCB. Replace outdoor inverter PCB.
Faulty compressor.	Check compressor. Check connections and wiring of the compressor. Check expansion valve (liquid back issue). Check the refrigerant charge. Refer to the nameplate for correct charge.	Replace compressor when required. Investigate reason of breakdown. Replace expansion valve when required. Fix possible leak.
Faulty or disturbance of the power supply (imbalance > 10%). Power drop. Short circuit.	Check if the power supply is conform with regulations. No fluctuations in frequency.	Adjust power supply when required. Power reset via outdoor unit.
Faulty outdoor fan motor.	Check the fan motor. Check fan motor connections and wiring.	Replace fan motor when required. Adjust wiring when required.
Faulty capacity adapter on outdoor PCB.	Check if the correct adapter is installed. Check if the correct spare part is installed.	Adjust capacity adapter when required.
External factory (e.g. electrical noise). (cause when error is reset after power reset, and error happens again after a while).	Check for source which could cause electrical interference.	Avoid electrical interference.

2.2.2.17. "L5-00" – Inverter instantaneous overcurrent (AC output)

Trigger	Effect	Reset
An output overcurrent is detected by checking the current that flows in the inverter DC section.	Unit will stop operating.	Manual reset via user interface.

Possible cause	Check	Corrective action
Installation of the unit is not in line with specifications.	Check the installation specifications. Refer to the installation manual.	Adjust the installation when required.
Refrigerant shortage.	Check for refrigerant shortage. Refer to the nameplate for the correct charge.	Charge the correct refrigerant amount when required.
Humidity in refrigerant (ice formation in expansion valve).	Check for humidity in the refrigerant.	In case of suspicion of humidity, recover, vacuum and recharge with virgin refrigerant.
Non condensables in refrigerant.	Check for non condensables in refrigerant.	In case of suspicion of non condensables, recover, vacuum and recharge with virgin refrigerant.
Stop valve is closed.	Check stop valve.	Open stop valve when required.
Faulty power module = faulty outdoor inverter PCB.	Check outdoor inverter PCB. Check if the HAP LED is blinking in regular intervals. Check if the correct spare part is installed.	Restore the power to the outdoor inverter PCB. Replace the outdoor inverter PCB when required.

Possible cause	Check	Corrective action
Faulty compressor.	Check compressor. Check connections and wiring of the compressor. Check expansion valve (liquid back issue). Check the refrigerant charge. Refer to the nameplate for correct charge.	Replace compressor when required. Investigate reason of breakdown. Replace expansion valve when required. Fix possible leak.
Faulty or disturbance of the power supply (imbalance > 10%). Power drop. Short circuit.	Check if the power supply is conform with regulations. No fluctuations in frequency.	Adjust power supply when required. Power reset via outdoor unit.

2.2.2.18. "L8-00" – Electronic thermal overload

Trigger	Effect	Reset
When compressor overload (except during start-up) is detected.	Unit will stop operating.	Manual reset via user interface.

Possible cause	Check	Corrective action
Refrigerant circuit is clogged.	Check for possible blockage.	Replace blocked part when required.
Refrigerant overcharge.	Check for refrigerant overcharge. Refer to the nameplate for the correct charge.	Charge the correct refrigerant amount when required.
Refrigerant is contaminated.		Replace refrigerant.
Faulty outdoor inverter PCB.	Check outdoor inverter PCB. Check if the alive led is blinking in regular intervals. Check if the correct spare part is installed.	Adjust the power to the outdoor inverter PCB. Replace outdoor inverter PCB.
Faulty compressor	Check compressor. Check connections and wiring of the compressor. Check expansion valve (liquid back issue). Check the refrigerant charge. Refer to the nameplate for correct charge.	Replace compressor when required. Investigate reason of breakdown. Replace expansion valve when required. Fix possible leak.

2.2.2.19. "L9-00" – Stall prevention time lag

Trigger	Effect	Reset
Outdoor inverter PCB detects compressor overload at start up.	Unit will stop operating.	Manual reset via user interface.

Possible cause	Check	Corrective action
Refrigerant circuit is clogged.	Check for possible blockage.	Replace blocked part when required.
Refrigerant condition is not OK (HP-LP > 0,2 MPa at start-up).	Check refrigerant condition.	
Faulty outdoor inverter PCB.	Check outdoor inverter PCB. Check if the alive led is blinking in regular intervals. Check if the correct spare part is installed.	Adjust the power to the outdoor inverter PCB. Replace outdoor inverter PCB.

Possible cause	Check	Corrective action
Faulty compressor.	Check compressor. Check connections and wiring of the compressor. Check expansion valve (liquid back issue). Check the refrigerant charge. Refer to the nameplate for correct charge.	Replace compressor when required. Investigate reason of breakdown. Replace expansion valve when required. Fix possible leak.

2.2.2.20. "LC-00" – Transmission system abnormality

Trigger	Effect	Reset
No transmission between outdoor main PCB and outdoor inverter PCB.	Unit will stop operating.	Automatic reset.

Possible cause	Check	Corrective action
Internal wiring is not OK.	Check if wiring between PCB's. (refer to wiring diagram).	Correct wiring.
Faulty outdoor unit main PCB.	Check if the HAP LED is blinking in regular intervals. Check if the correct spare part is installed. Check if the outdoor main PCB receives power.	Adjust the power to the outdoor main PCB. Replace outdoor main PCB when HAP LED is not blinking in regular intervals.
Faulty outdoor inverter PCB.	Check outdoor inverter PCB. Check if the alive led is blinking in regular intervals. Check if the correct spare part is installed.	Adjust the power to the outdoor inverter PCB. Replace outdoor inverter PCB.
Faulty capacity adapter on outdoor PCB.	Check if the correct adapter is installed. Check if the correct spare part is installed.	Adjust capacity adapter when required.
External factory (e.g. electrical noise). (cause when error is reset after power reset, and error happens again after a while).	Check for source which could cause electrical interference.	Avoid electrical interference.

2.2.2.21. "P1-00" – Open phase or power supply voltage imbalance

Trigger	Effect	Reset
Outdoor inverter PCB detects incorrect power supply.	Unit will stop operating.	Manual reset via user interface. Automatic reset.

Possible cause	Check	Corrective action
Faulty outdoor unit main PCB.	Check if the HAP LED is blinking in regular intervals. Check if the correct spare part is installed. Check if the outdoor main PCB receives power.	Adjust the power to the outdoor main PCB. Replace outdoor main PCB when HAP LED is not blinking in regular intervals.
Faulty outdoor inverter PCB.	Check outdoor inverter PCB. Check if the alive led is blinking in regular intervals. Check if the correct spare part is installed.	Adjust the power to the outdoor inverter PCB. Replace outdoor inverter PCB.
Faulty or disturbance of the power supply (imbalance > 10%). Power drop. Short circuit.	Check if the power supply is conform with regulations. No fluctuations in frequency.	Adjust power supply when required. Power reset via outdoor unit.

Possible cause	Check	Corrective action
Faulty capacity adapter on outdoor PCB.	Check if the correct adapter is installed. Check if the correct spare part is installed.	Adjust capacity adapter when required.

2.2.2.22. "P4-00" – Radiating fin temperature sensor abnormality

Trigger	Effect	Reset
Radiating fin thermistor input voltage is < 0.04 V or > 4.96 V when power is on.	Unit will stop operating.	Manual reset via user interface.

Possible cause	Check	Corrective action
Faulty radiating fin thermistor.	Check radiating fin thermistor.	Replace radiating fin thermistor when required.
Faulty outdoor unit PCB in which radiating fin thermistor is connected.	Check if the HAP LED is blinking in regular intervals. Check if the correct spare part is installed. Check if the outdoor main PCB receives power.	Restore the power to the outdoor main PCB. Replace outdoor main PCB when HAP LED is not blinking in regular intervals.

2.2.2.23. "PJ-00" – Capacity setting abnormality

Trigger	Effect	Reset
Outdoor main PCB detects a defective capacity in EEPROM.	Unit will stop operating.	Manual reset via user interface. Power supply reset.

Possible cause	Check	Corrective action
Position of PCB dip switches are not OK.	Check if dip switches are set to default (OFF) position.	
Faulty outdoor unit main PCB.	Check if the HAP LED is blinking in regular intervals. Check if the correct spare part is installed. Check if the outdoor main PCB receives power.	Adjust the power to the outdoor main PCB. Replace outdoor main PCB when HAP LED is not blinking in regular intervals.
Faulty capacity adapter on outdoor PCB.	Check if the correct adapter is installed. Check if the correct spare part is installed.	Adjust capacity adapter when required.

2.2.3. System

2.2.3.1. “U0-00” – Refrigerant shortage

Trigger	Effect	Reset
Refrigerant shortage detected.	Unit will stop operating.	Automatic reset. Power reset via outdoor unit.

Possible cause	Check	Corrective action
Faulty air thermistor.	Check air thermistor.	Replace air thermistor when required.
Faulty discharge thermistor.	Check discharge thermistor.	Replace discharge thermistor when required.
Faulty outdoor heat exchanger thermistor.	Check outdoor heat exchanger thermistor.	Replace outdoor heat exchanger thermistor when required.
Stop valve is closed.	Check stop valve.	Open stop valve when required.
Refrigerant shortage.	Check for refrigerant shortage. Refer to the nameplate for the correct charge.	Charge the correct refrigerant amount when required.
Humidity in refrigerant (ice formation in expansion valve).	Check for humidity in the refrigerant.	In case of suspicion of humidity, recover, vacuum and recharge with virgin refrigerant.
Non condensables in refrigerant.	Check for non condensables in refrigerant.	In case of suspicion of non condensables, recover, vacuum and recharge with virgin refrigerant.
Faulty compressor.	Check compressor. Check connections and wiring of the compressor. Check expansion valve (liquid back issue). Check the refrigerant charge. Refer to the nameplate for the correct charge.	Replace compressor when required. Investigate reason of breakdown. Replace expansion valve when required. Fix possible leak.
Faulty expansion valve.	Check the expansion valve.	Replace the expansion valve body or motor when required.

2.2.3.2. “U1-00” – Reverse phase or open phase

Trigger	Effect	Reset
Outdoor main PCB detects incorrect power supply.	Unit will stop operating.	Manual reset via user interface. Automatic reset.

Possible cause	Check	Corrective action
Faulty outdoor unit main PCB.	Check if the HAP LED is blinking in regular intervals. Check if the correct spare part is installed. Check if the outdoor main PCB receives power.	Adjust the power to the outdoor main PCB. Replace outdoor main PCB when HAP LED is not blinking in regular intervals.
Faulty or disturbance of the power supply (imbalance > 10%). Power drop. Short circuit.	Check if the power supply is conform with regulations. No fluctuations in frequency.	Adjust power supply when required. Power reset via outdoor unit.
Faulty capacity adapter on outdoor PCB.	Check if the correct adapter is installed. Check if the correct spare part is installed.	Adjust capacity adapter when required.

2.2.3.3. "U2-00" – Power supply abnormality or instantaneous power failure

Trigger	Effect	Reset
There is no zero-cross detected in approximately 10 seconds (indoor unit PCB).	Unit will stop operating.	Power reset via outdoor unit.
Abnormal voltage drop (< 150-180 V) is detected by the DC voltage detection circuit.	Unit will stop operating.	Automatic restart after compressor stand-by of 3 minutes.
Abnormal voltage rise is detected by the over-voltage detection circuit.	Unit will stop operating.	Automatic restart after compressor stand-by of 3 minutes.

Possible cause	Check	Corrective action
Faulty or disturbance of the power supply (imbalance > 10%). Power drop. Short circuit.	Check if the power supply is conform with regulations. No fluctuations in frequency.	Adjust power supply when required. Power reset via outdoor unit.
Defective DC voltage detection circuit.	Check PCB with DC voltage detection circuit.	Replace PCB when required.
Defective over-voltage detection circuit.	Check PCB with over-voltage detection circuit.	Replace PCB when required.
Defective PAM control part.	Check PAM control part.	Replace PAM control part when required.
Faulty compressor.	Check compressor. Check connections and wiring of the compressor. Check expansion valve (liquid back issue). Check the refrigerant charge. Refer to the nameplate for correct charge.	Replace compressor when required. Investigate reason of breakdown. Replace expansion valve when required. Fix possible leak.
Faulty outdoor fan motor.	Check the fan motor. Check fan motor connections and wiring.	Replace fan motor when required. Adjust wiring when required.
Momentary drop of voltage.	-	Wait until compressor restarts.
Momentary power failure.	-	Wait until compressor restarts.
Faulty outdoor unit main PCB.	Check if the HAP LED is blinking in regular intervals. Check if the correct spare part is installed. Check if the outdoor main PCB receives power.	Restore the power to the outdoor main PCB. Replace outdoor main PCB when HAP LED is not blinking in regular intervals.
Faulty indoor unit main PCB.	Check if the HAP LED is blinking in regular intervals. Check if the correct spare part is installed. Check if the indoor main PCB receives power.	Restore the power to the indoor main PCB. Replace indoor main PCB when HAP LED is not blinking in regular intervals.

2.2.3.4. "U4-00" – Transmission abnormality between indoor unit and outdoor unit

Trigger	Effect	Reset
Data sent from outdoor unit cannot be received normally, content of the send data is abnormal.	Unit will stop operating.	Power reset via outdoor unit.

Possible cause	Check	Corrective action
Faulty or disturbance of the power supply (imbalance > 10%). Power drop. Short circuit.	Check if the power supply is conform with regulations. No fluctuations in frequency.	Adjust power supply when required. Power reset via outdoor unit.

Possible cause	Check	Corrective action
Wiring abnormality between indoor unit and outdoor unit.	Check wiring between indoor unit and outdoor unit.	Adjust wiring between indoor unit and outdoor unit when required. Replace wiring between indoor unit and outdoor unit when required.
Faulty outdoor unit main PCB.	Check if the HAP LED is blinking in regular intervals. Check if the correct spare part is installed. Check if the outdoor main PCB receives power.	Restore the power to the outdoor main PCB. Replace outdoor main PCB when HAP LED is not blinking in regular intervals.
Faulty outdoor fan motor.	Check the fan motor. Check fan motor connections and wiring.	Replace fan motor when required. Adjust wiring when required.
Faulty indoor unit main PCB.	Check if the HAP LED is blinking in regular intervals. Check if the correct spare part is installed. Check if the indoor main PCB receives power.	Restore the power to the indoor main PCB. Replace indoor main PCB when HAP LED is not blinking in regular intervals.
Standby electricity saving mode is ON but there is a sky-air indoor installed on the unit.	If the indoor unit is NOT a sky-air indoor. This mode is only compatible with split indoor units.	Put "standby electricity saving function" OFF (see installation manual).

2.2.3.5. "UA-00" – Improper combination of indoor unit and outdoor unit

Trigger	Effect	Reset
Signal transmission between indoor unit and outdoor unit abnormality.	Unit will stop operating.	Power reset via outdoor unit.

Possible cause	Check	Corrective action
Improper combination of indoor unit and outdoor unit.	Check combination.	Adjust installation when required.
Wiring abnormality between indoor unit and outdoor unit.	Check wiring between indoor unit and outdoor unit.	Adjust wiring between indoor unit and outdoor unit when required. Replace wiring between indoor unit and outdoor unit when required.
Faulty outdoor unit main PCB.	Check if the HAP LED is blinking in regular intervals. Check if the correct spare part is installed. Check if the outdoor main PCB receives power.	Restore the power to the outdoor main PCB. Replace outdoor main PCB when HAP LED is not blinking in regular intervals.
Faulty indoor unit main PCB.	Check if the HAP LED is blinking in regular intervals. Check if the correct spare part is installed. Check if the indoor main PCB receives power.	Restore the power to the indoor main PCB. Replace indoor main PCB when HAP LED is not blinking in regular intervals.
Standby electricity saving mode is ON but there is a sky-air indoor installed on the unit.	If the indoor unit is NOT a sky-air indoor. This mode is only compatible with split indoor units.	Put "standby electricity saving function" OFF (see installation manual).

2.2.3.6. "UF-00" – Wiring and piping mismatch

Trigger	Effect	Reset
When the interunit wiring between indoor and outdoor unit is incorrect. Piping abnormality.	Unit will stop operating.	Automatic reset.

Possible cause	Check	Corrective action
Faulty wiring between indoor and outdoor unit.	Check wiring between indoor and outdoor unit.	Correct wiring.
Refrigerant shortage (incorrect charge/leakage).	Check for refrigerant shortage. Perform a leak test.	If required, repair the leak and charge the correct amount of refrigerant.
Refrigerant circuit is clogged.	Check for possible blockage (Blockages can be checked by measuring the refrigerant/pipe temperature. Sudden drop in temperature could indicate a blockage. (Remark: This is not valid for the expansion valve.)).	

2.2.4. Others

Not applicable.

2.3. Symptom based troubleshooting

2.3.1. Indoor unit

Not available yet.

2.3.2. Outdoor unit

Not available yet.

2.3.3. System

Not available yet.

2.3.4. Others

Not available yet.

2.4. Component checklist

Overview of component checklists:

Indoor unit	46
Fan motor	46
Outdoor unit.....	47
4-way valve	47
Compressor.....	49
Electronic expansion valve.....	51
Fan motor	53
High pressure switch.....	54
Low pressure switch.....	55
Main PCB	56
Refrigerant thermistors.....	58
System	61
Others	61

2.4.1. Indoor unit

2.4.1.1. Fan motor

Technical specification		Description	
The motor has a single connector for DC power and the rotation counter feed back from the integrated pulse generator (4 pulses/revolution).		The fan motor runs on a fixed speed to supply the required air flow rate.	
Location			
Piping diagram	Wiring diagram	Switch box	Component overview of unit
See "Indoor unit" on page 128.	See "Indoor unit" on page 123.	Not applicable.	Not applicable.
Check procedure			
Mechanical check			

PRELIMINARY ACTIONS

1. Switch off the Daikin unit via the user interface.
2. Switch off the Daikin unit with the field supplied circuit breaker.
3. Remove casing when required.

PROCEDURE

1. Check the state of the rotor, replace the rotor if damaged, deformed, cracked or broken.
2. Check the motor shaft bearing friction, only perform electrical check if motor runs with low shaft bearing friction. Replace fan motor if friction is abnormal.

Electrical check

PRELIMINARY ACTIONS

1. Switch off the Daikin unit via the user interface.
2. Switch off the Daikin unit with the field supplied circuit breaker.
3. Remove casing when required.

PROCEDURE

1. Check fuse on indoor PCB, replace if blown.



WARNING: RISK OF FIRE

When reconnecting a connector to the PCB, do not apply force, as this may damage the connector or connector pins of the PCB.

2. Check if fan motor connector is plugged into PCB.
3. Power the Daikin unit.
4. Check power supply, the measured voltage must be 198 - 240 VAC, if not replace indoor PCB.

2.4.2. Outdoor unit

2.4.2.1. 4-way valve

Technical specification		Description	
-		The 4-way valve directs the super heated refrigerant discharged from the compressor to the indoor heat exchanger in case of heating operation or to the outdoor heat exchanger in case of defrosting and cooling operation.	
Location			
Piping diagram	Wiring diagram	Switch box	Component overview of unit
See "Outdoor unit" on page 128.	See "Outdoor unit" on page 124.	See "Outdoor unit" on page 133.	See "Outdoor unit" on page 130.
Check procedure			
Mechanical check			

PRELIMINARY ACTIONS

1. Switch off the Daikin unit via the user interface.
2. Switch off the Daikin unit with the field supplied circuit breaker.
3. Remove plate work when required (refer to "Basic removal" on page 69).

PROCEDURE

1. Loosen the screw and remove the coil from the 4-way valve (refer to "Replacing 4-way valve coil" on page 78).



WARNING: RISK OF FIRE

When reconnecting a connector to the PCB, do not apply force, as this may damage the connector or connector pins of the PCB.

2. Unplug 4-way valve connector from applicable PCB, see table "Component checklist" on page 132.
3. Switch the circuit breaker on.
4. Switch on the Daikin unit via the user interface, start cooling/defrost operation.

If the temperature after the heat exchanger drops, proceed with next step.

If the temperature after the heat exchanger rises, the 4-way valve is stuck in heating position, replace the 4-way valve body (refer to "Replacing 4-way valve body" on page 77).

If the temperature after the heat exchanger does not rise, check the refrigerant pressure by connecting a manifold to one of the service ports.

 - If no pressure is measured, perform a pressure test and fix any leaks.
 - If pressure is measured, the 4-way valve is stuck in the middle, confirm by determining the position of the 4-way valve as described below and replace the 4-way valve (refer to "Replacing 4-way valve body" on page 77).



CAUTION - RISK OF LIQUID ENTERING THE COMPRESSOR

To prevent damage to the compressor the step below must only be done once.

5. While listening to the 4-way valve, place a round permanent magnet on the core of the solenoid valve. If you do not hear the 4-way valve switching, it must be replaced (refer to "Replacing 4-way valve body" on page 77).

Electrical check

PRELIMINARY ACTIONS

1. Switch off Daikin unit via the user interface.
2. Switch off Daikin unit with the field supplied circuit breaker.
3. Remove plate work when required (refer to ["Basic removal" on page 69](#)).

PROCEDURE

1. Switch on the Daikin unit, start heating operation.



WARNING: RISK OF FIRE

When reconnecting a connector to the PCB, do not apply force, as this may damage the connector or connector pins of the PCB.

2. Measure the voltage on 4-way valve connector: pin 1-3, see table ["Component checklist" on page 132](#). If the measured voltage does not range 220-240 VAC during switching / 15 VAC after switching, unplug 4-way valve connector from PCB and measure the voltage directly on the PCB: pin 1-3 of 4-way valve connection.
 - If the voltage, measured directly on the PCB does not range 220-240 VAC during switching / 15 VAC after switching, replace main PCB.
 - If the voltage, measured directly on the PCB does range 220-240 VAC during switching / 15 VAC after switching, replace the 4-way valve coil (refer to ["Replacing 4-way valve coil" on page 78](#)).



WARNING: RISK OF FIRE

When reconnecting a connector to the PCB, do not apply force, as this may damage the connector or connector pins of the PCB.

3. Unplug 4-way valve connector from PCB and measure the resistance of the 4-way valve coil. If the measured resistance does not range 1000 - 2000 Ω , replace the 4-way valve coil (refer to ["Replacing 4-way valve coil" on page 78](#)).
4. Switch on the Daikin unit, start cooling/defrost operation.
If the temperature after the plate type heat exchanger rises, the control of the 4-way valve is wrong. Replace main PCB.

Determine the position of the 4-way valve

1. Switch off Daikin unit via the user interface.
2. Switch off Daikin unit with the field supplied circuit breaker.
3. Slide a magnet over the front and the rear of the 4-way valve body and sense the attraction of the magnet to determine the valve position.
4. If the magnet is attracted in positions A,A' or B,B', the 4-way valve is OK; if the magnet is attracted in positions C,C' the 4-way valve must be replaced (refer to ["Replacing 4-way valve body" on page 77](#)).

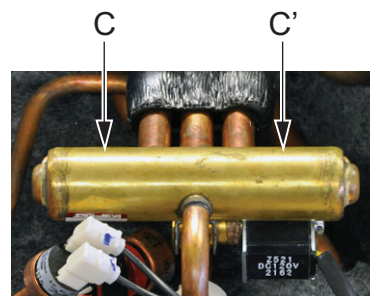
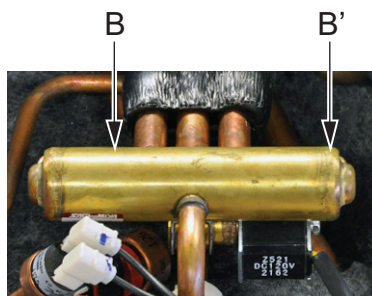
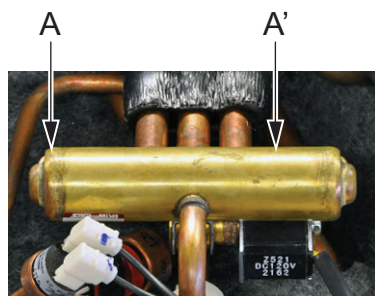

2.4.2.2. Compressor

Technical specification		Description	
Type: inverter driven, swing double swing.		The compressor compresses the refrigerant in the refrigerant circuit.	
Location			
Piping diagram	Wiring diagram	Switch box	Component overview of unit
See "Outdoor unit" on page 128.	See "Outdoor unit" on page 124.	See "Outdoor unit" on page 133.	See "Outdoor unit" on page 130.
Check procedure			
Preliminary check			

1. Check if the Daikin unit is connected to earth.
2. Check if the stop valve is open.

Mechanical check

PRELIMINARY ACTIONS

1. Switch off the Daikin unit via the user interface.
2. Switch off the Daikin unit with the field supplied circuit breaker.
3. Remove plate work when required (refer to "Basic removal" on page 69).

PROCEDURE

1. Open the compressor insulation.
2. Check if the condition of the compressor dampers and piping is correct.

Electrical check

PRELIMINARY ACTIONS

1. Switch off the Daikin unit via the user interface.
2. Switch off the Daikin unit with the field supplied circuit breaker.
3. Remove plate work when required.

PROCEDURE

1. Open the compressor insulation.
2. Switch on the Daikin unit and measure the U, V, W inverter voltages. All voltages must be identical, if not, replace the inverter PCB.
3. Switch off the Daikin unit via the user interface.
4. Switch off the Daikin unit with the field supplied circuit breaker.



INFORMATION

Note the position of the cables on the compressor wire terminals to allow identical wiring during reinstallation.

5. Disconnect the Faston connectors U, V and W from the compressor, take picture.
6. Measure the compressor motor windings U-V, V-W and U-W.

7. Megger the compressor using 500 or 1000 VDC, the insulation must be higher than 3 MΩ.
8. Replace the compressor if the windings and/or insulation measurements fail (refer to ["Replacing compressor" on page 79](#)).
9. Run the compressor and measure the current in each phase; the current for each phase should be identical (refer to ["Product specific information" on page 132](#)). In that case it can be decided to preventively replace the compressor (refer to ["Replacing compressor" on page 79](#)).

2.4.2.3. Electronic expansion valve

Technical specification		Description	
The electronic expansion valve has a hermetically sealed body with a slide-on stepping motor drive coil (480 pulses from fully closed to fully open position).		The electronic expansion valve is used: <ul style="list-style-type: none"> To control the flow of refrigerant. Depending on location, the trigger point is sub-cool and/or superheat. To stop the flow of refrigerant completely when closing (= 0 pulses). 	
Location			
Piping diagram	Wiring diagram	Switch box	Component overview of unit
See "Outdoor unit" on page 128.	See "Outdoor unit" on page 124.	See "Outdoor unit" on page 133.	See "Outdoor unit" on page 130.
Check procedure			
Mechanical check			

PRELIMINARY ACTIONS

- Switch off the Daikin unit via the user interface.
- Switch off the Daikin unit with the field supplied circuit breaker.
- Switch on the Daikin unit and listen to the expansion valve assembly, if the expansion valve body does not create a latching sound, continue with the electrical check.
- Switch off the Daikin unit via the user interface.
- Switch off the Daikin unit with the field supplied circuit breaker.
- Remove plate work when required (refer to "Basic removal" on page 69).

PROCEDURE

- Remove the expansion valve coil from the expansion valve body.
- Slide the magnet (tool part N° 9950038) over the expansion valve body and gently rotate the magnet to manually operate the expansion valve body clockwise (closing) and counterclockwise (opening).
- If it is not possible to open the expansion valve body with the magnet, the expansion valve body is blocked and the expansion valve body must be replaced (refer to "Replacing expansion valve body" on page 85).

Electrical check

PRELIMINARY ACTIONS

- Switch off the Daikin unit via the user interface.
- Switch off the Daikin unit with the field supplied circuit breaker.
- Remove plate work when required (refer to "Basic removal" on page 69).

PROCEDURE

- Check if the electrical connector of the expansion valve coil was correctly connected to the PCB, if not, connect the electrical connector.
- Disconnect the electrical connector of the expansion valve coil and check the continuity between below pins using a multi meter. It should be ± the same value.
 - Connector pin 1-6: connected
 - Connector pin 2-6: connected

- Connector pin 3-6: connected
- Connector pin 4-6: connected

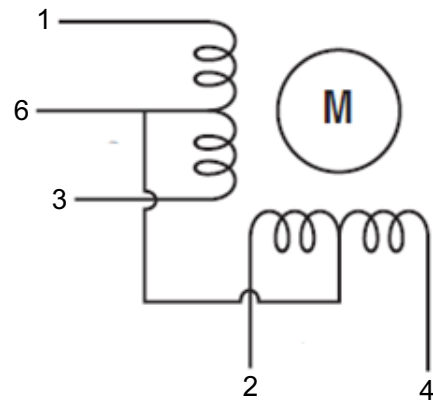
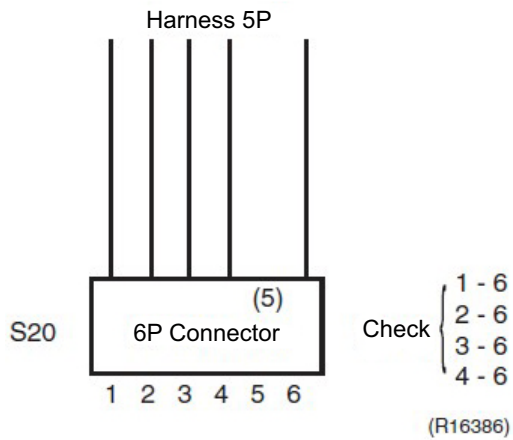

3. If one or more of the windings have no continuity, replace the expansion valve coil.

2.4.2.4. Fan motor

Technical specification		Description	
The motor has a single connector for DC power and the rotation counter feed back from the integrated pulse generator (4 pulses/revolution).		The fan motor runs on a fixed speed to supply the required air flow rate.	
Location			
Piping diagram	Wiring diagram	Switch box	Component overview of unit
See "Outdoor unit" on page 128.	See "Outdoor unit" on page 124.	See "Outdoor unit" on page 133.	See "Outdoor unit" on page 130.
Check procedure			
Mechanical check			

PRELIMINARY ACTIONS

1. Switch off the Daikin unit via the user interface.
2. Switch off the Daikin unit with the field supplied circuit breaker.
3. Remove plate work when required (refer to "Basic removal" on page 69).

PROCEDURE

1. Check the state of the propeller, replace the propeller if damaged, deformed, cracked or broken (refer to "Replacing propeller fan blade assembly" on page 101).
2. Check the motor shaft bearing friction, only perform electrical check if motor runs with low shaft bearing friction. Replace fan motor if friction is abnormal (refer to "Replacing DC fan motor assembly" on page 82).

Electrical check

PRELIMINARY ACTIONS

1. Switch off the Daikin unit via the user interface.
2. Switch off the Daikin unit with the field supplied circuit breaker.
3. Remove plate work when required (refer to "Basic removal" on page 69).

PROCEDURE

1. Check fuse on PCB, replace if blown, see table "Component checklist" on page 132.



WARNING: RISK OF FIRE

When reconnecting a connector to the PCB, do not apply force, as this may damage the connector or connector pins of the PCB.

2. Check if fan motor connector is plugged into PCB.
3. Power the Daikin unit.
4. Check power supply, the measured voltage must be 198 - 240 VAC, if not replace main PCB (refer to "Replacing main PCB" on page 94).

2.4.2.5. High pressure switch

Technical specification		Description	
The high pressure switch has a normally closed contact. If the pressure exceeds 41.7 (+0 / -1) bar the contact will open; if the pressure drops below 32 (±2) bar the contact will close.		The high pressure switch is a safety component that stops the compressor if overpressure is detected in the refrigerant circuit.	
Location			
Piping diagram	Wiring diagram	Switch box	Component overview of unit
See "Outdoor unit" on page 128.	See "Outdoor unit" on page 124.	See "Outdoor unit" on page 133.	See "Outdoor unit" on page 130.
Check procedure			
Electrical check			

PRELIMINARY ACTIONS

1. Switch off the Daikin unit via the user interface.
2. Switch off the Daikin unit with the field supplied circuit breaker.
3. Remove plate work when required (refer to ["Basic removal" on page 69](#)).

PROCEDURE

1. Disconnect the high pressure switch connector from applicable PCB, see table ["Component checklist" on page 132](#).
2. Recover the refrigerant.
3. Pressurize the refrigerant circuit at 41.7 bar with nitrogen.
4. Measure the switch contacts between high pressure switch connector: pins 1-2; the switch must be open.
5. Replace the high pressure switch if the contact is not open (refer to ["Replacing high pressure switch" on page 91](#)).
6. Lower the refrigerant circuit pressure to 30 bar.
7. Measure the switch contacts between high pressure switch connector: pins 1-2; the switch must be closed.
8. Replace the high pressure switch if the contact is not closed (refer to ["Replacing high pressure switch" on page 91](#)).

2.4.2.6. Low pressure switch

Technical specification		Description	
The low pressure switch has a normally closed contact. If the pressure drops below -0,31 ($\pm 0,2$) bar, the contact will open. When the pressure rises above 0,51 ($\pm 0,3$) bar the contact will close again.		The low pressure switch is a safety component that stops the compressor if under-pressure is detected in the refrigerant circuit.	
Location			
Piping diagram	Wiring diagram	Switch box	Component overview of unit
See "Outdoor unit" on page 128.	See "Outdoor unit" on page 124.	See "Outdoor unit" on page 133.	See "Outdoor unit" on page 130.
Check procedure			
Electrical check			

PRELIMINARY ACTIONS

1. Switch off the Daikin unit via the user interface.
2. Switch off the Daikin unit with the field supplied circuit breaker.
3. Remove plate work when required (refer to "Basic removal" on page 69).

PROCEDURE

1. Disconnect the low pressure switch connector from applicable PCB.
2. Recover the refrigerant.
3. Connect vacuum pump to gas service port and vacuum to -0,5 bar.
4. Measure the switch contacts between low pressure switch connector: pins 1-2; the switch must be open.
5. Replace the low pressure switch if the contact is not open (refer to "Replacing high pressure switch" on page 91).
6. Increase the refrigerant circuit pressure to 1 bar.
7. Measure the switch contacts between low pressure switch connector: pins 1-2; the switch must be closed.
8. Replace the low pressure switch if the contact is not closed (refer to "Replacing high pressure switch" on page 91).

2.4.2.7. Main PCB

Technical specification		Description	
Location			
Piping diagram	Wiring diagram	Switch box	Component overview of unit
See "Outdoor unit" on page 128.	See "Outdoor unit" on page 124.	See "Outdoor unit" on page 133.	See "Outdoor unit" on page 130.
Check procedure			
Mechanical check			

Not applicable.

Electrical check

PRELIMINARY ACTIONS

1. Switch off the Daikin unit via the user interface.
2. Switch off the Daikin unit with the field supplied circuit breaker.
3. Remove plate work when required (refer to "Basic removal" on page 69).

PROCEDURE

1. Switch on the Daikin unit with the field supplied circuit breaker.
2. Switch on the Daikin unit via the user interface.
3. Check if the HAP LED is blinking in regular intervals (1/0.5 sec), if not blinking, replace the main PCB board (refer to "Replacing main PCB" on page 94).
4. Measure the supply voltage to the main PCB board: there should be ± 220 V between brown and blue cable. If not correct voltage, replace the electrical noise filter PCB (refer to "Replacing electrical noise filter" on page 83).
5. Switch off the Daikin unit via the user interface.
6. Switch off the Daikin unit with the field supplied circuit breaker.
7. Remove plate work when required.
8. Open the compressor insulation.
9. Remove the terminal cover of compressor wiring.

**WARNING: RISK OF ELECTROCUTION**

The smoothing capacitor must discharge below 10 VDC before removing the compressor wiring.

10. Measure the voltage on S70: pin 7-4 and wait until it drops below 10 VDC.

**INFORMATION**

Note the position of the cables on the compressor wire terminals to allow identical wiring during reinstallation.

11. Disconnect the compressor wires and connect the compressor wires to the Inverter Analyzer (SPP number 1368521).



12. Power the Daikin unit.

**WARNING**

Electrical shock hazard. Do not touch live wires.

13. Activate the inverter test (refer to "[Component checklist](#)" on page 132).

14. Check that all LED's on the Inverter Analyzer are lit; if not, replace the inverter board (refer to "[Replacing inverter PCB](#)" on page 92).

15. Switch off the Daikin unit with the field supplied circuit breaker.

16. Wait a few minutes and confirm that the LED's on the Inverter Analyzer are off.

17. Disconnect the Inverter Analyzer from the U V W wiring.

**CAUTION**

When wiring the compressor, observe UV W as indicated on the compressor.

18. Reconnect the U V W leads to the compressor.

2.4.2.8. Refrigerant thermistors

Technical specification		Description	
A single type of thermistor is used; the resistance vs. temperature characteristics is shown in below table "Thermistor resistance / temperature characteristics (type 1)".		The thermistors are used to measure the temperature at multiple locations inside the Daikin unit. The measured temperatures are processed by the main board.	
Location			
Piping diagram	Wiring diagram	Switch box	Component overview of unit
See "Outdoor unit" on page 128.	See "Outdoor unit" on page 124.	See "Outdoor unit" on page 133.	See "Outdoor unit" on page 130.
Check procedure			
Mechanical check			

PRELIMINARY ACTIONS

1. Switch off the Daikin unit via the user interface.
2. Switch off the Daikin unit with the field supplied circuit breaker.
3. Locate the thermistor and check if thermal contact with the piping or ambient is ensured.

Electrical check



INFORMATION

If a thermistor check fails, replace the thermistor.

PRELIMINARY ACTIONS

1. Switch off the Daikin unit via the user interface.
2. Switch off the Daikin unit with the field supplied circuit breaker.
3. Remove plate work when required.

PROCEDURE

1. From the table in the appendix ("Component checklist" on page 132), select the thermistor that must be checked.
2. Measure the temperature of the thermistor using a contact thermometer.



WARNING: RISK OF FIRE

When reconnecting a connector to the PCB, do not apply force, as this may damage the connector or connector pins of the PCB.

3. Unplug the connector from the appropriate PCB and measure the resistance between the pins listed in the table in the appendix ("Component checklist" on page 132).
 - Compare the measured resistance with the range determined by the lower and higher temperature.
4. If the measured resistance does not match the listed value, the thermistor must be replaced.



INFORMATION

All thermistors have a tolerance of 5%.

E.g. R3T air thermistor - main PCB - connector S90: pin 1-2 type 1:

- Measured temperature with contact thermometer: 23.1°C.
- Unplug the sensor and measure the resistance between S90: 1-2: 21.86 kΩ.

- The resistance values are defined by below table "Thermistor resistance / temperature characteristics (type 1)":
 - Resistance at 23°C: 21.85 kΩ.
 - Resistance at 24°C: 20.90 kΩ.
- The measured value 21.86 kΩ is inside the range, thermistor R3T passes the check.

**INFORMATION**

The user interface allows to monitor most thermistors.

If the measured resistance of the thermistor matches the temperature measured with the contact thermometer but the temperature for the corresponding thermistor is not correct on the user interface display, replace applicable PCB.

Table 2-1: Thermistor resistance / temperature characteristics (type 1)

T °C	kΩ	T °C	kΩ	T °C	kΩ	T °C	kΩ	T °C	kΩ
-20	197.81	0	65.84	20	25.01	40	10.63	60	4.87
-19	186.53	1	62.54	21	23.91	41	10.21	61	4.70
-18	175.97	2	59.43	22	22.85	42	9.81	62	4.54
-17	166.07	3	56.49	23	21.85	43	9.42	63	4.38
-16	156.80	4	53.71	24	20.90	44	9.06	64	4.23
-15	148.10	5	51.09	25	20.00	45	8.71	65	4.08
-14	139.94	6	48.61	26	19.14	46	8.37	66	3.94
-13	132.28	7	46.26	27	18.32	47	8.05	67	3.81
-12	125.09	8	44.05	28	17.54	48	7.75	68	3.68
-11	118.34	9	41.95	29	16.80	49	7.46	69	3.56
-10	111.99	10	39.96	30	16.10	50	7.18	70	3.44
-9	106.03	11	38.08	31	15.43	51	6.91	71	3.32
-8	100.41	12	36.30	32	14.79	52	6.65	72	3.21
-7	95.14	13	34.62	33	14.18	53	6.41	73	3.11
-6	90.17	14	33.02	34	13.59	54	6.65	74	3.01
-5	85.49	15	31.50	35	13.04	55	6.41	75	2.91
-4	81.08	16	30.06	36	12.51	56	6.18	76	2.82
-3	76.93	17	28.70	37	12.01	57	5.95	77	2.72
-2	73.01	18	27.41	38	11.52	58	5.74	78	2.64
-1	69.32	19	26.18	39	11.06	59	5.14	79	2.55
								80	2.47

Table 2-2: Thermistor resistance / temperature characteristics (type 3)

T °C	kΩ	T °C	kΩ	T °C	kΩ	T °C	kΩ	T °C	kΩ
—	—	30.0	184.1	70.0	36.3	110.0	9.6	150.0	3.2
—	—	32.0	168.3	72.0	33.7	112.0	9.0	152.0	3.0
-6.0	1120.0	34.0	154.0	74.0	31.4	114.0	8.5	154.0	2.9
-4.0	1002.5	36.0	141.0	76.0	29.2	116.0	8.0	156.0	2.7
-2.0	898.6	38.0	129.3	78.0	27.2	118.0	7.6	158.0	2.6
0.0	806.5	40.0	118.7	80.0	25.4	120.0	7.1	160.0	2.5
2.0	724.8	42.0	109.0	82.0	23.7	122.0	6.7	162.0	2.3
4.0	652.2	44.0	100.2	84.0	22.1	124.0	6.4	164.0	2.5
6.0	587.6	46.0	92.2	86.0	20.7	126.0	6.0	166.0	2.1
8.0	530.1	48.0	84.9	88.0	19.3	128.0	5.7	168.0	2.0
10.0	478.8	50.0	78.3	90.0	18.1	130.0	5.4	170.0	1.9
12.0	432.9	52.0	72.2	92.0	16.9	132.0	5.4	172.0	1.9
14.0	392.0	54.0	66.7	94.0	15.8	134.0	4.8	174.0	1.8
16.0	355.3	56.0	61.6	96.0	14.8	136.0	4.6	176.0	1.7
18.0	322.4	48.0	57.0	98.0	13.9	138.0	4.3	178.0	1.6
20.0	292.9	60.0	52.8	100.0	13.1	140.0	4.1	180.0	1.5

T °C	kΩ	T °C	kΩ	T °C	kΩ	T °C	kΩ	T °C	kΩ
22.0	266.3	62.0	48.9	102.0	12.3	142.0	3.9	—	
24.0	242.5	64.0	45.3	104.0	11.5	144.0	3.7		
26.0	221.0	66.0	42.0	106.0	10.8	146.0	3.5		
28.0	201.6	68.0	39.0	108.0	10.2	148.0	3.3		

Table 2-3: Thermistor resistance / temperature characteristics (air thermistor FTXM-M)

T °C	kΩ	T °C	kΩ	T °C	kΩ	T °C	kΩ	T °C	kΩ
-32,5	237,01	-6,0	46,5	20,5	12,3	47,0	4,0	73,5	1,6
-32,0	229,08	-5,5	45,3	21,0	12,0	47,5	3,9	74,0	1,5
-31,5	221,45	-5,0	44,0	21,5	11,7	48,0	3,9	74,5	1,5
-31,0	214,10	-4,5	42,8	22,0	11,4	48,5	3,8	75,0	1,5
-30,5	207,02	-4,0	41,7	22,5	11,2	49,0	3,7	75,5	1,5
-30,0	200,20	-3,5	40,6	23,0	10,9	49,5	3,7	76,0	1,4
-29,5	193,64	-3,0	39,5	23,5	10,7	50,0	3,6	76,5	1,4
-29,0	187,32	-2,5	38,4	24,0	10,5	50,5	3,5	77,0	1,4
-28,5	181,22	-2,0	37,4	24,5	10,2	51,0	3,5	77,5	1,4
-28,0	175,35	-1,5	36,4	25,0	10,0	51,5	3,4	78,0	1,4
-27,5	169,70	-1,0	35,5	25,5	9,8	52,0	3,3	78,5	1,3
-27,0	164,24	-0,5	34,5	26,0	9,6	52,5	3,3	79,0	1,3
-26,5	158,99	0,0	33,6	26,5	9,4	53,0	3,2	79,5	1,3
-26,0	153,92	0,5	32,7	27,0	9,2	53,5	3,1	80,0	1,3
-25,5	149,03	1,0	31,9	27,5	9,0	54,0	3,1	80,5	1,3
-25,0	144,32	1,5	31,1	28,0	8,8	54,5	3,0	81,0	1,2
-24,5	139,77	2,0	30,3	28,5	8,6	55,0	3,0	81,5	1,2
-24,0	135,39	2,5	29,5	29,0	8,4	55,5	2,9	82,0	1,2
-23,5	131,15	3,0	28,7	29,5	8,2	56,0	2,9	82,5	1,2
-23,0	127,07	3,5	28,0	30,0	8,0	56,5	2,8	83,0	1,2
-22,5	123,13	4,0	27,3	30,5	7,9	57,0	2,8	83,5	1,1
-22,0	119,33	4,5	26,6	31,0	7,7	57,5	2,7	84,0	1,1
-21,5	115,66	5,0	25,9	31,5	7,5	58,0	2,7	84,5	1,1
-21,0	112,11	5,5	25,3	32,0	7,4	58,5	2,6	85,0	1,1
-20,5	108,69	6,0	24,6	32,5	7,2	59,0	2,6	85,5	1,1
-20,0	105,38	6,5	24,0	33,0	7,1	59,5	2,5	86,0	1,1
-19,5	102,19	7,0	23,4	33,5	6,9	60,0	2,5	86,5	1,0
-19,0	99,11	7,5	22,8	34,0	6,8	60,5	2,4	87,0	1,0
-18,5	96,13	8,0	22,3	34,5	6,6	61,0	2,4	87,5	1,0
-18,0	93,25	8,5	21,7	35,0	6,5	61,5	2,4	88,0	1,0
-17,5	90,47	9,0	21,2	35,5	6,4	62,0	2,3	88,5	1,0
-17,0	87,78	9,5	20,7	36,0	6,2	62,5	2,3	89,0	1,0
-16,5	85,19	10,0	20,2	36,5	6,1	63,0	2,2	89,5	0,9
-16,0	82,67	10,5	19,7	37,0	6,0	63,5	2,2	90,0	0,9
-15,5	80,25	11,0	19,2	37,5	5,9	64,0	2,2	90,5	0,9
-15,0	77,90	11,5	18,7	38,0	5,7	64,5	2,1	91,0	0,9
-14,5	75,63	12,0	18,3	38,5	5,6	65,0	2,1	91,5	0,9
-14,0	73,43	12,5	17,9	39,0	5,5	65,5	2,1	92,0	0,9
-13,5	71,31	13,0	17,4	39,5	5,4	66,0	2,0	92,5	0,9
-13,0	69,25	13,5	17,0	40,0	5,3	66,5	2,0	93,0	0,9
-12,5	67,27	14,0	16,6	40,5	5,2	67,0	1,9	93,5	0,8
-12,0	65,34	14,5	16,2	41,0	5,1	67,5	1,9	94,0	0,8

T °C	kΩ	T °C	kΩ	T °C	kΩ	T °C	kΩ	T °C	kΩ
-11,5	63,48	15,0	15,8	41,5	5,0	68,0	1,9	94,5	0,8
-11,0	61,68	15,5	15,5	42,0	4,9	68,5	1,9	95,0	0,8
-10,5	59,93	16,0	15,1	42,5	4,8	69,0	1,8	95,5	0,8
-10,0	58,25	16,5	14,8	43,0	4,7	69,5	1,8	96,0	0,8
-9,5	56,61	17,0	14,4	43,5	4,6	70,0	1,8	96,5	0,8
-9,0	55,03	17,5	14,1	44,0	4,5	70,5	1,7	97,0	0,8
-8,5	53,50	18,0	13,8	44,5	4,4	71,0	1,7	97,5	0,7
-8,0	52,01	18,5	13,4	45,0	4,3	71,5	1,7	98,0	0,7
-7,5	50,57	19,0	13,1	45,5	4,3	72,0	1,6	98,5	0,7
-7,0	49,18	19,5	12,8	46,0	4,2	72,5	1,6	99,0	0,7
-6,5	47,83	20,0	12,5	46,5	4,1	73,0	1,6	99,5	0,7

2.4.3. System

Not applicable.

2.4.4. Others

Not applicable.

2.5. Other capacity range

Not applicable.

Part 3. Repair

This part contains the following chapters:

Refrigerant repair procedures	63
Service tools	67
Unit specific repair procedures	68

3.1. Refrigerant repair procedures

Overview:

Refrigerant piping handling	63
Recovery procedure	63
Refrigerant pump down	65
Piping repair procedures	66

3.1.1. Refrigerant piping handling

- Make sure the applied pressure is never higher than the unit design pressure as indicated on the nameplate (PS).
- Work according the F-gas regulation and/or local regulations.
- Make sure the correct amount according the F-gas regulation label on the unit (factory + additional where required) of refrigerant is charged after repair.
- Make sure to use the appropriate equipment and tools according to the refrigerant and unit type.
- Charge non-azeotropic refrigerant (e.g. R-410A) always in a liquid state.
- R32 can be charged in gas phase.
- Make sure to use a digital scale (no charging cylinder).
- Execute correct vacuum drying procedure after repair work:
 - -0,1 MPa / -760 mmHg / -750 Torr / -1 bar for at least 1 hour.
 - Connect the unit according the available service ports, refer to ["Recovery procedure" on page 63](#).
 - Use related field setting where necessary to open expansion valve/solenoid valve.

3.1.2. Recovery procedure

3.1.2.1. Outdoor unit casing

1. Switch off the Daikin unit via the user interface.
2. Manually open the expansion valve (located on the outdoor unit).
3. Connect the vacuum pump, manifold, recovery unit and refrigerant bottle to the service port as shown below.
For the location of the service ports, refer to ["Outdoor unit" on page 128](#).

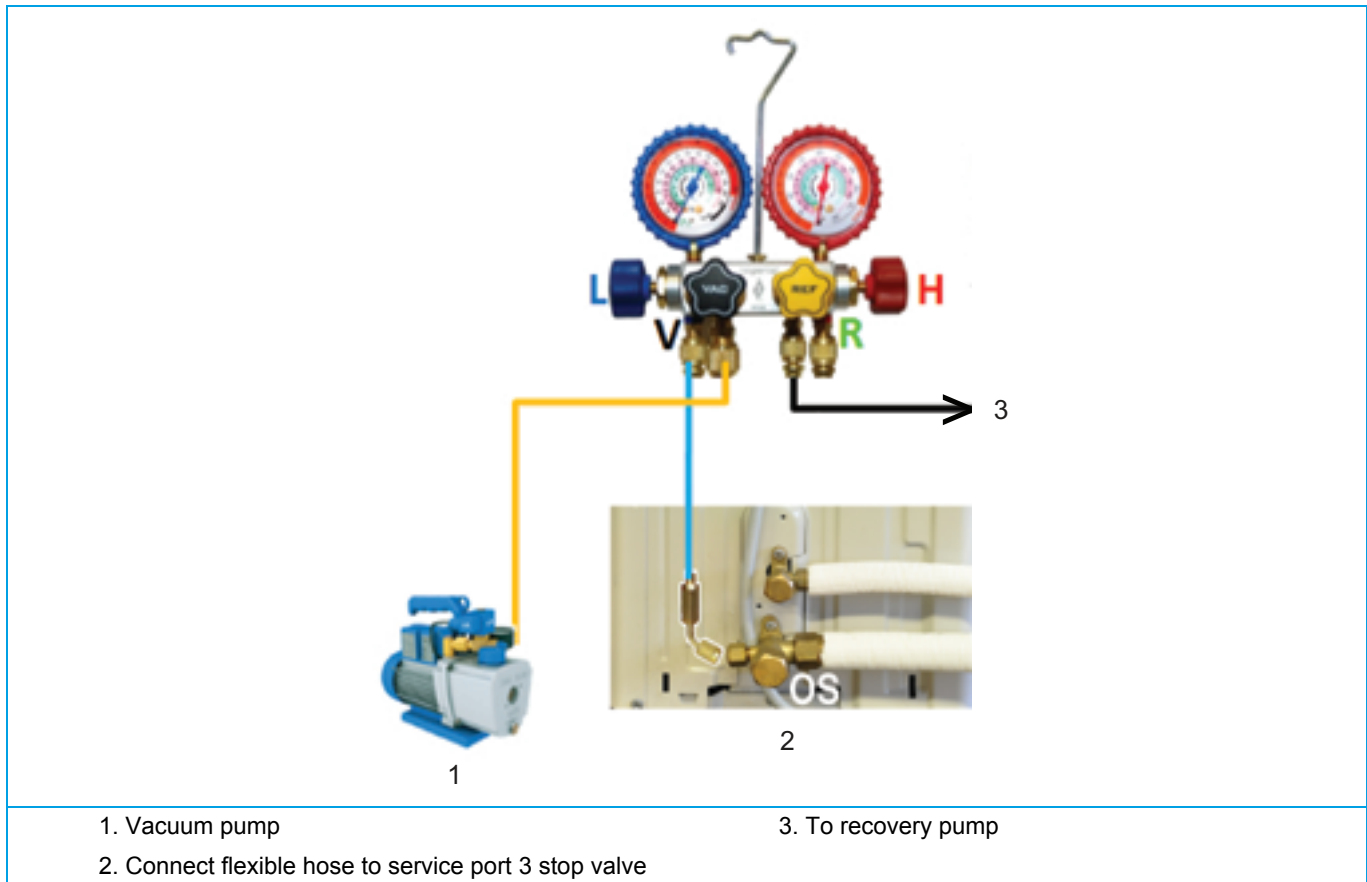
In case of 1 service port at the stop valves**Figure 3-1: 1 service port at the stop valves****INFORMATION**

See instruction of the recovery pump supplier how to recover the refrigerant.

In case of 2 service ports at the stop valves

Connect both stop valve service ports to the manifold.

In case of 3 service ports at the stop valves

Connect 1 hose to the suction stop valve service port and 1 hose to the service port between the expansion valve and outdoor H/E.

Figure 3-2: 3 service ports at the stop valves

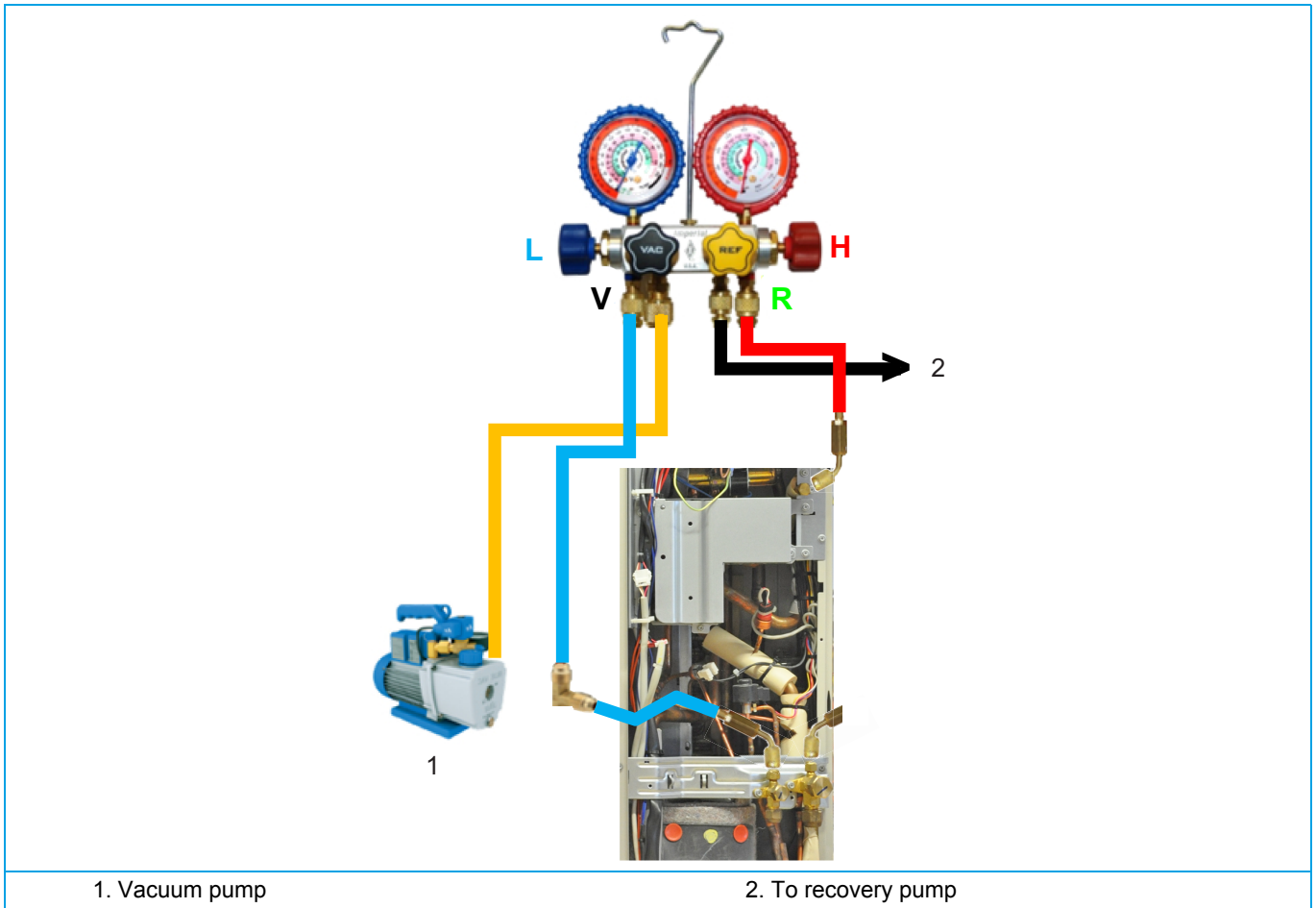

1. Vacuum pump

2. To recovery pump



INFORMATION

See instruction of the recovery pump supplier how to recover the refrigerant.

3.1.3. Refrigerant pump down

This unit is equipped with an automatic pump down operation which will collect all refrigerant from the field piping and indoor unit in the outdoor unit. To protect the environment, make sure to perform the following pump down operation when relocating the unit.



WARNING: RISK OF EXPLOSION

- When the refrigeration circuit has a leak, do not execute pump down with the compressor.
- Use recovery system into separate cylinder.
- Warning, explosive hazard exists when executing pump down.
- Pump down with compressor can lead to self-combustion due to air entering during pump down.



INFORMATION

Some outdoor units are equipped with a low pressure switch to protect the compressor by switching it off. Never short-circuit the low pressure switch during pump down operation!

3.1.3.1. Small outdoor unit

1. Remove the valve lid from liquid stop valve and gas stop valve.
2. Carry out pump down operation.



CAUTION

Refer to Installer Reference Guide for 'Pump down operation' procedure.

3. After 5-10 min (after only 1-2 min in case of very low Ta < -10°C), close the liquid stop valve with a hexagonal wrench.
4. Check on manifold if vacuum is reached, close gas stop valve and forced cooling operation.

3.1.3.2. Large outdoor unit

1. Stop all demands for the Daikin unit.
2. Switch OFF / ON the power supply of the outdoor unit.
3. Carry out pump down operation.



CAUTION

Refer to Installer Reference Guide for 'Pump down operation' procedure.

4. The compressor and outdoor fan will start automatically.
5. Request heating via remote controller to prevent HE freeze-up.
6.
 - a. Check on manifold if vacuum is reached, close gas stop valve and forced cooling operation.
 - b. Once operation stops (after 3 to 5 minutes), close the liquid and the gas stop valve.
7. Pump down is now finished. U4 may be displayed on the remote controller, this is not a malfunction.
8. (After "pump down" is finished or stopped, keep the circulation pump running for at least 5 minutes.)
9. Switch OFF the power supply of the outdoor unit.



NOTE

- Make sure to re-open both stop valves before restart operation of the unit.
- After a finished or stopped pump down, the unit will perform a test run at first operation (same as during commissioning).

3.1.4. Piping repair procedures

- Make sure to cover open pipe ends during repair work so no dust or moisture can enter.
- Make sure to re-apply insulation removed during repair.
- Pipe expansion / flare making:
 - Remove any burrs on the cut surface and use correct tool such as reamer or scraper (note that excessive deburring can thin the pipe walls and cause cracking of the pipe).
 - Make sure the flare has the correct size (use a flare gauge).
 - Make sure no particles remain in the piping.
 - Apply just a drop of refrigerant oil on the inner surface of the flare.
 - Make sure the flare connection is tightened with the correct torque (torque values refer to installation manual).
- Brazing:
 - Use correct brazing tool.
 - Use a phosphor copper filler metal (silver composition of 0 to 2%). Do not use flux material.
 - Flush the piping before brazing with nitrogen to avoid oxidation of the inside of the copper tubes (nitrogen purity ≥ 99,99%).

3.2. Service tools

For an overview of the applicable service tools, please check the Daikin Business Portal: <http://www.mydaikin.eu>

Go to the tab “After-sales support” on the left side and then select “Technical support”.

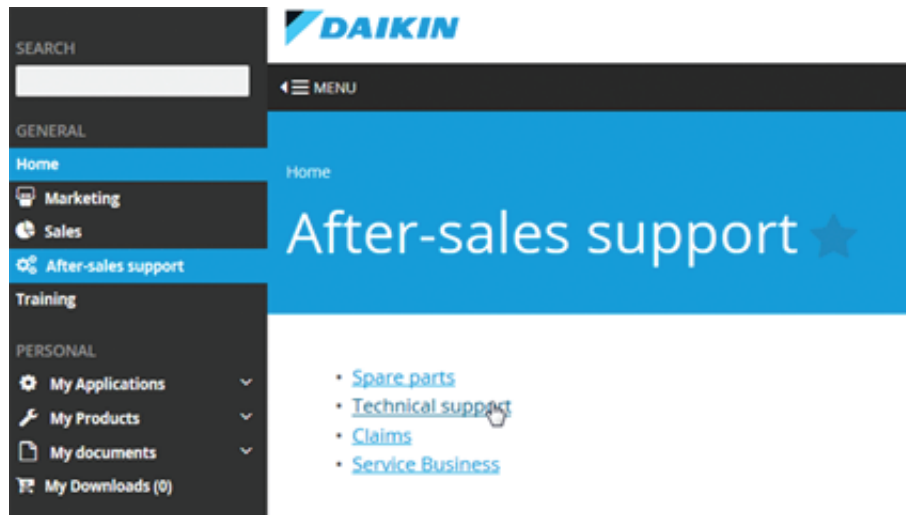

You will then find a button “Service tools” which gives you an overview on which service tool to use for which product. Also additional information on the service tool (instruction, latest software) can be found there.

3.3. Unit specific repair procedures

Overview:

Indoor unit.....	68
Outdoor unit.....	69
Basic removal.....	69
Replacing thermistor.....	75
Replacing 4-way valve body.....	77
Replacing 4-way valve coil.....	78
Replacing accumulator assembly.....	79
Replacing compressor.....	79
Replacing DC fan motor assembly.....	82
Replacing electrical noise filter.....	83
Replacing expansion valve body.....	85
Replacing expansion valve motor.....	87
Replacing solenoid valve.....	88
Replacing solenoid valve coil.....	90
Replacing high pressure switch.....	91
Replacing inverter PCB.....	92
Replacing low pressure switch.....	92
Replacing main PCB.....	94
Replacing propeller fan blade assembly.....	101

3.3.1. Indoor unit

Not applicable.

3.3.2. Outdoor unit

3.3.2.1. Basic removal

PRELIMINARY ACTIONS

1. Switch off the Daikin unit via the user interface.
2. Switch off the Daikin unit with the field supplied circuit breaker.

PROCEDURE

Removal

1. Loosen and remove the 9 screws (1) that fix the top plate assembly (2).
2. Lift the top plate assembly (2) and remove it from the Daikin unit.

Figure 3-3: Removing the top plate assembly



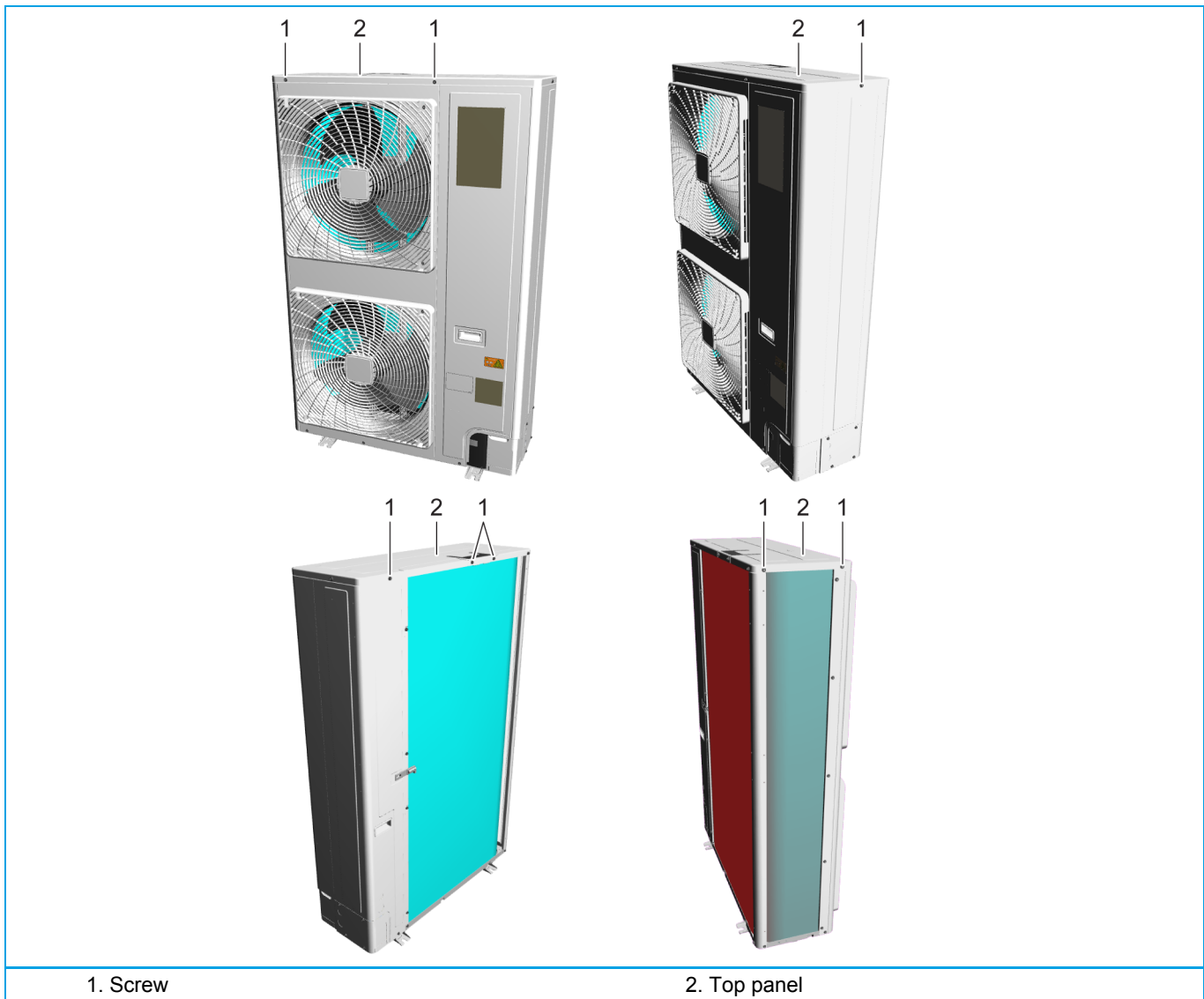

3. Loosen and remove the screw (1) that fixes the front plate (2).
4. Lift the front plate (2) and remove it from the unit.

Figure 3-4: Removing the front plate

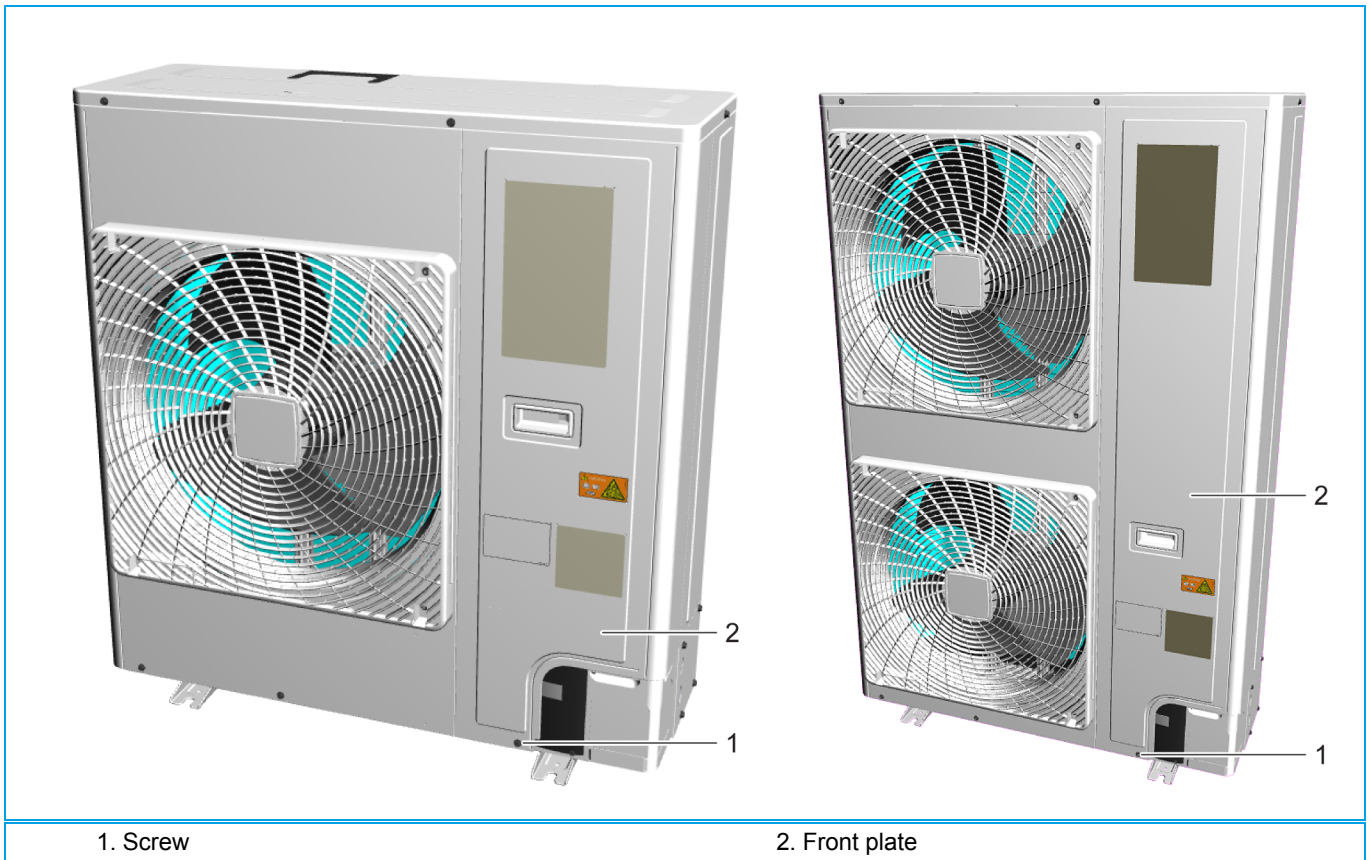

1. Screw

2. Front plate

5. Loosen and remove the 11 screws (1) that fix the front plate assembly (3).
6. Loosen and remove the screw (2) that fixes the front plate assembly (3).



CAUTION

The screw (2) has a different length.

7. Lift the front plate assembly (3) and remove it from the unit.

Figure 3-5: Removing the front plate assembly

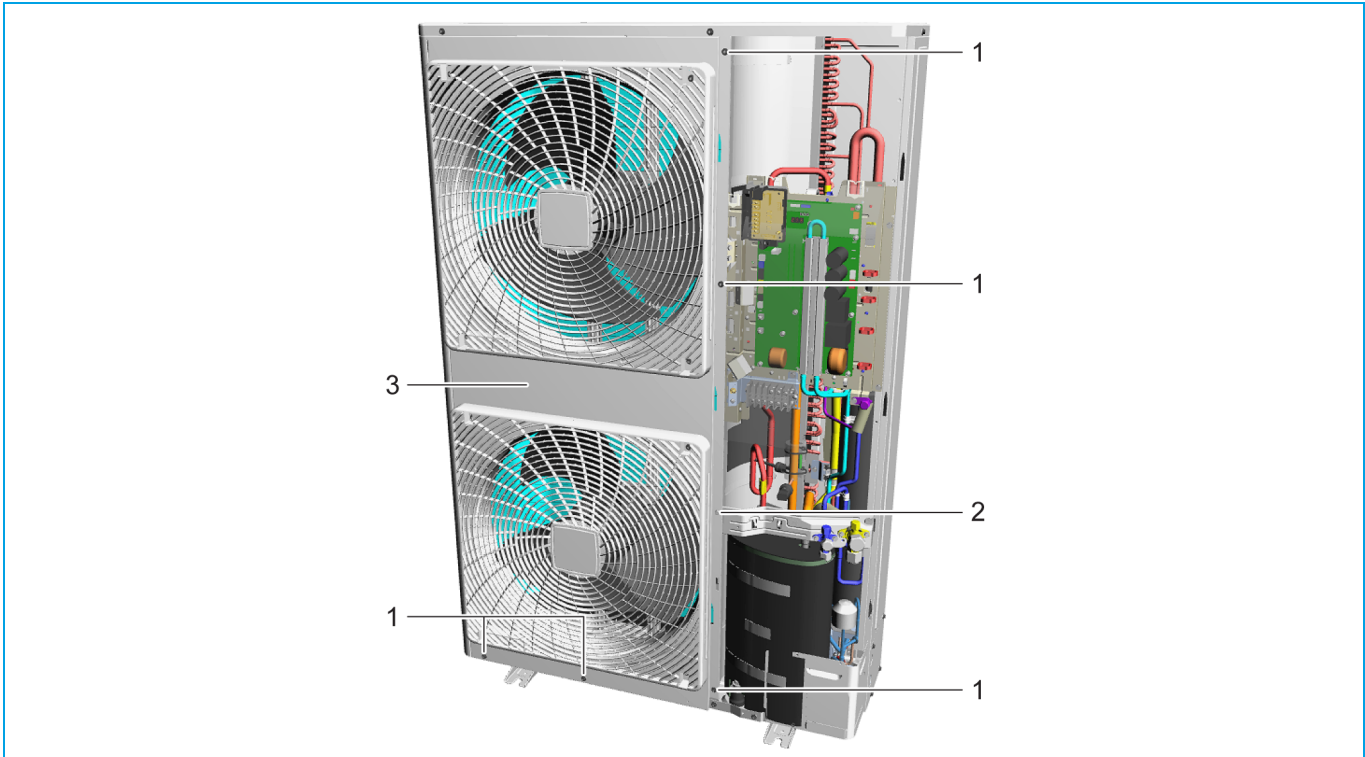
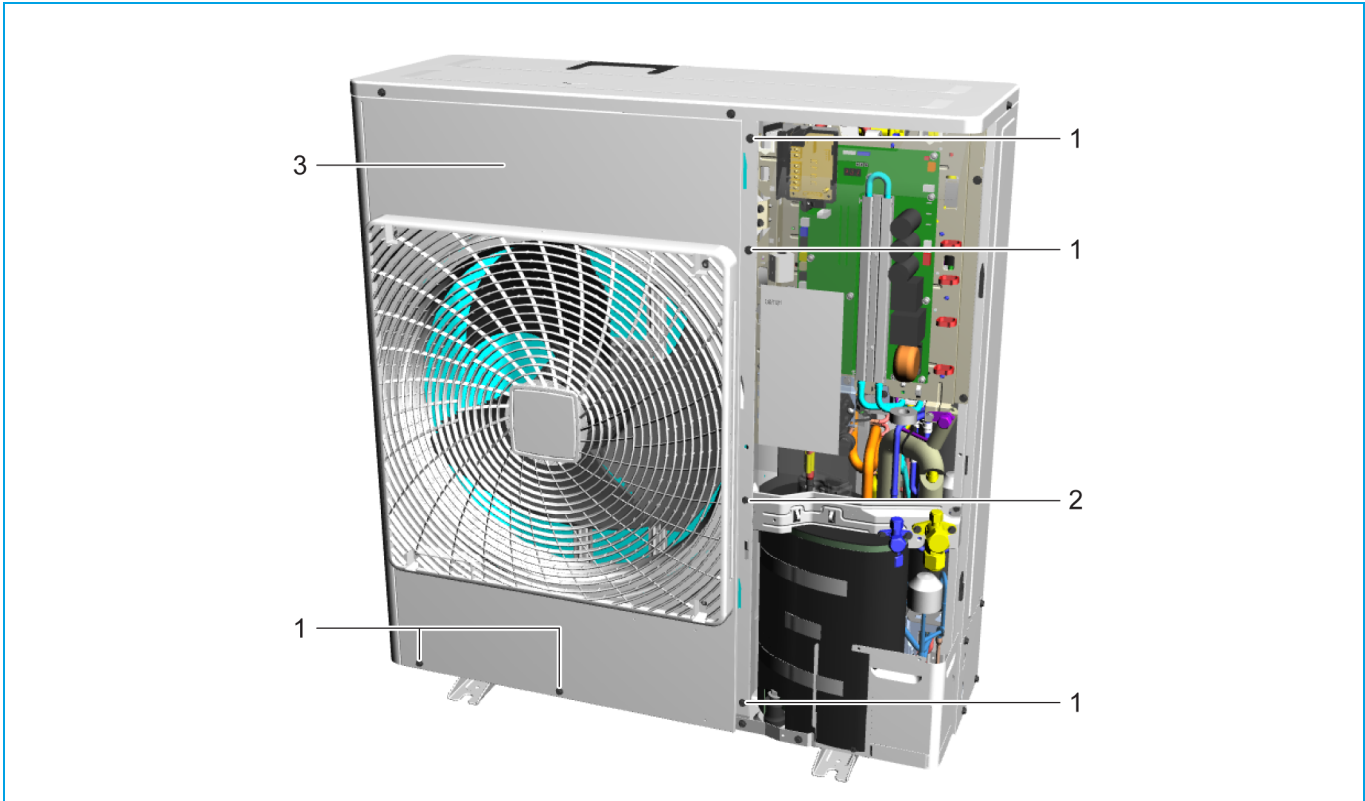

- 1. Screw
- 2. Screw

3. Front plate assembly

8. Loosen and remove the screw (1) that fixes the cover (2).

9. Remove the cover (1) from the unit.

Figure 3-6: Removing the cover

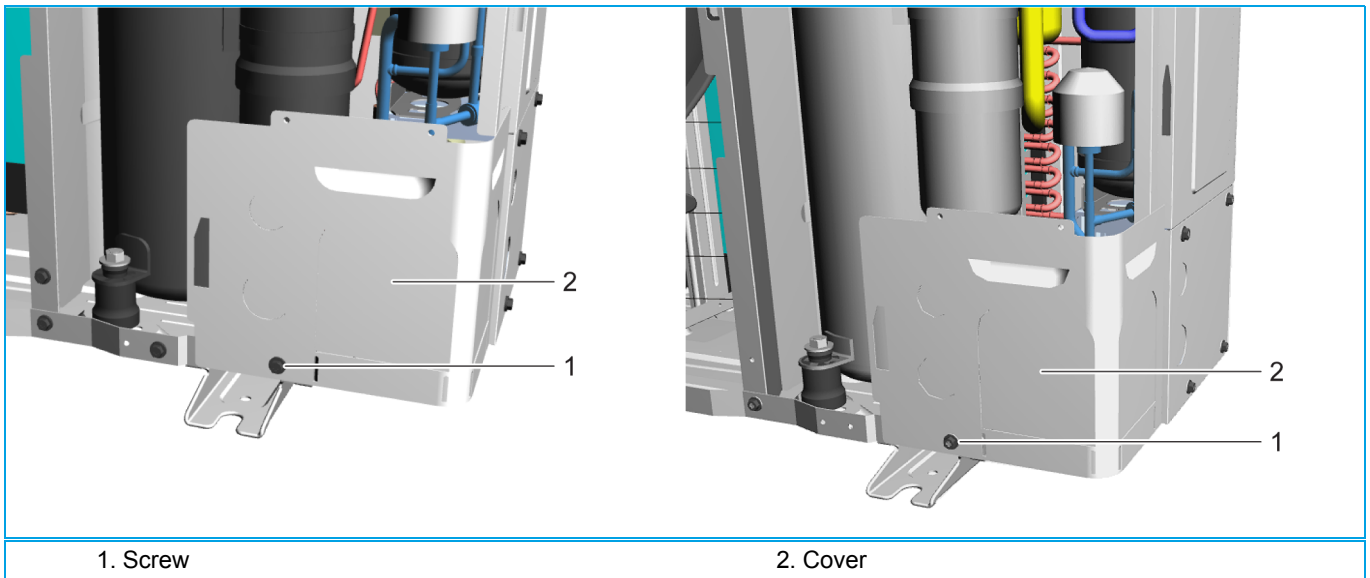

10. Loosen and remove the screw (1) that fixes the piping cover (2).

11. Remove the piping cover (2) from the unit.

Figure 3-7: Removing the piping cover

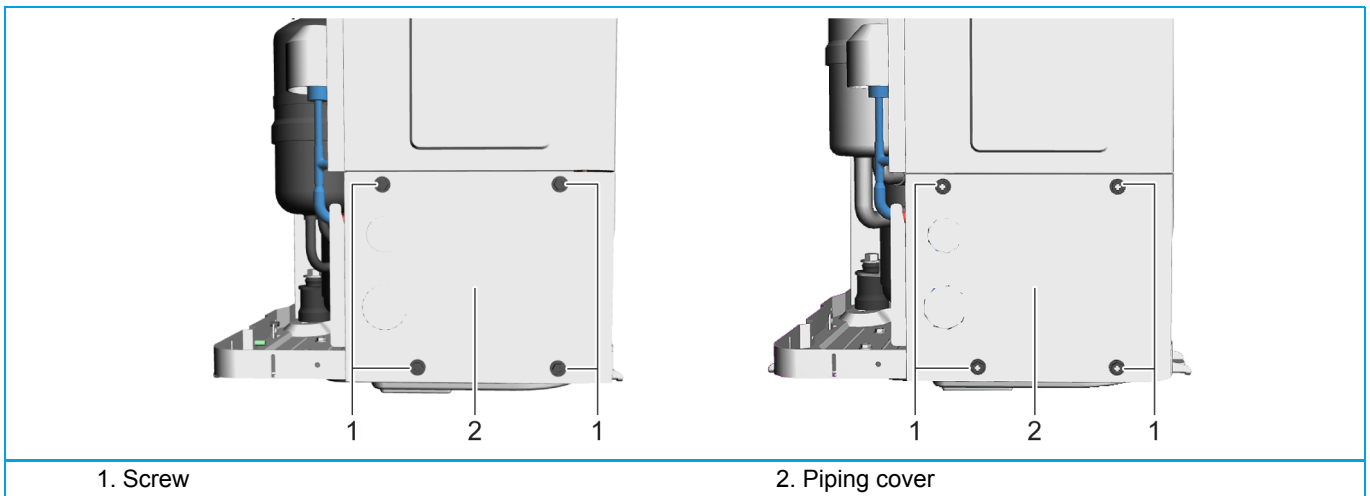

12. Loosen the thermistor fixing plate (2).

13. Slightly twist the right side of the thermistor fixing plate (2), and gently pull the left side of the thermistor fixing plate (2) until it unlatches.

14. Slide the thermistor fixing plate (2) until it detaches from the right side plate (4).

15. Turn over the thermistor fixing plate (2) and unlatch the thermistor cover.

16. Remove thermistor R1T (1) from the thermistor fixing plate (2).

17. Remove the thermistor fixing plate (2).

18. Guide the thermistor R1T (1) into the unit.

19. Loosen and remove the 5 screws (3) that fix the right side plate (4).

20. Remove the right side plate (4) from the unit.

Figure 3-8: Removing the right side plate

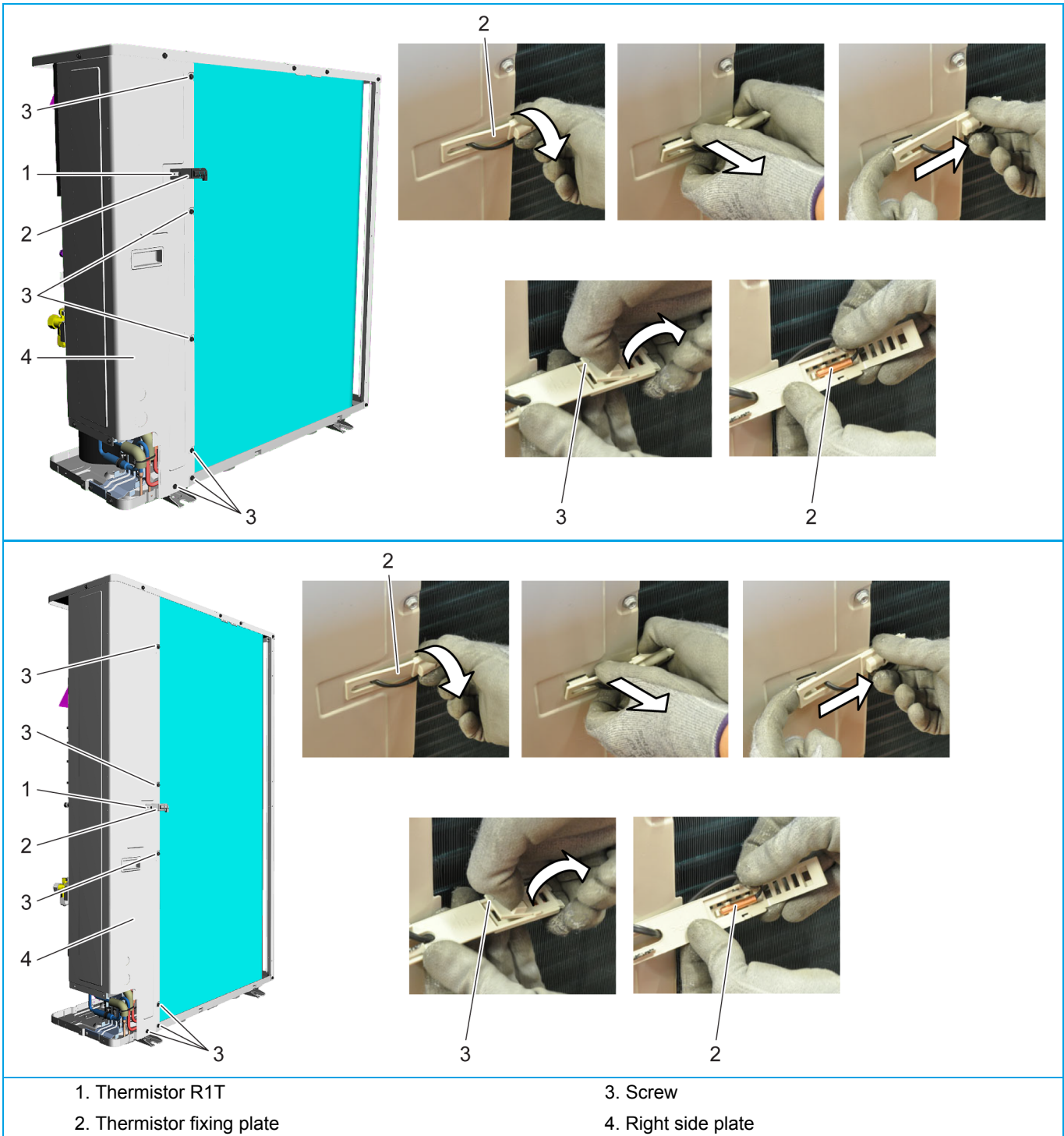

3.3.2.2. Replacing thermistor

PRELIMINARY ACTIONS

1. Switch off the Daikin unit via the user interface.
2. Switch off the Daikin unit with the field supplied circuit breaker.
3. Remove plate work when required (refer to "Basic removal" on page 69).

PROCEDURE

Removal

1. Locate the thermistor that needs to be replaced, see table below and [figure 3-10 "Thermistor location" on page 76](#).

Thermistor	Processed on PCB	Connector / colour
R1T (air)	Main	X11A
R2T (discharge)	Main	X12A / yellow
R3T (suction)	Main	X12A / green
R4T (heat exchanger)	Main	X12A / red
R5T (heat exchanger middle)	Main	X12A / white
R6T (liquid)	Main	X13A: / blue
R7T, R8T (Positive Temperature Coefficient)	-	-

2. Cut the tie wraps (1) that fix the insulation (3) and the thermistor wire (2).
3. Cut the insulation (3) and remove it.
4. Pull the clip (5) that fixes the thermistor (6).
5. Remove the thermistor (6) from the thermistor holder (4).

Figure 3-9: Replacing a thermistor

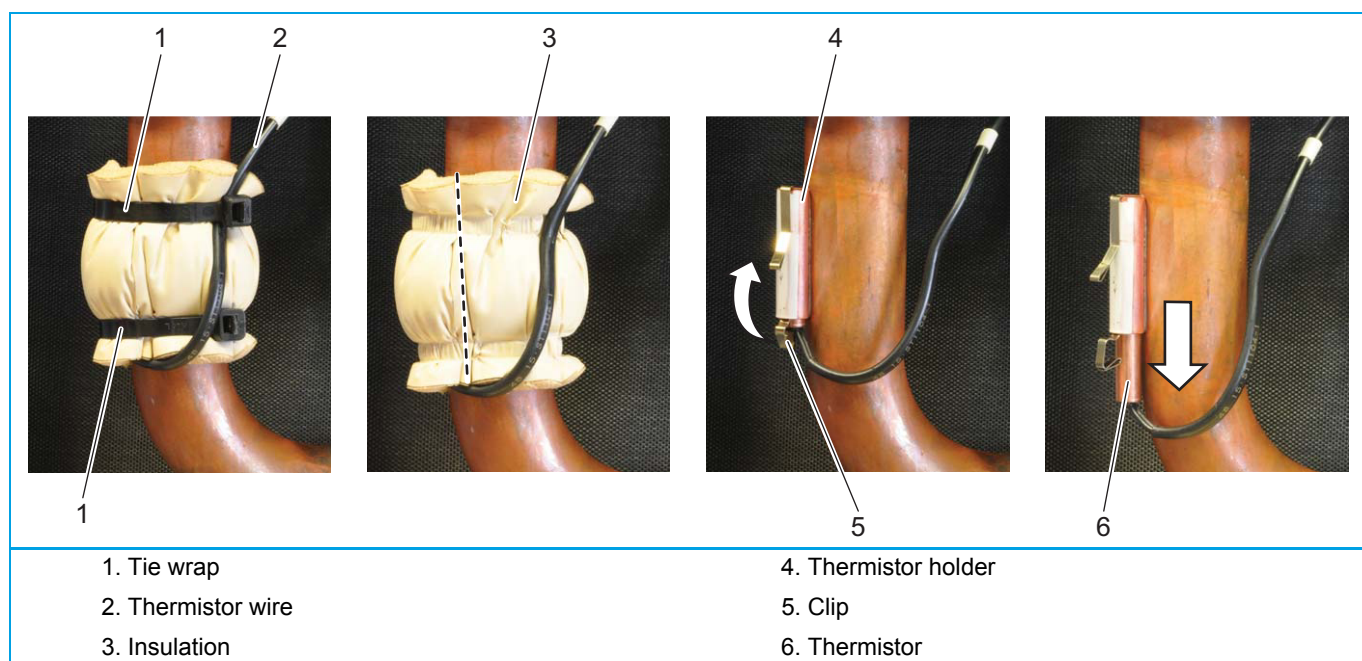
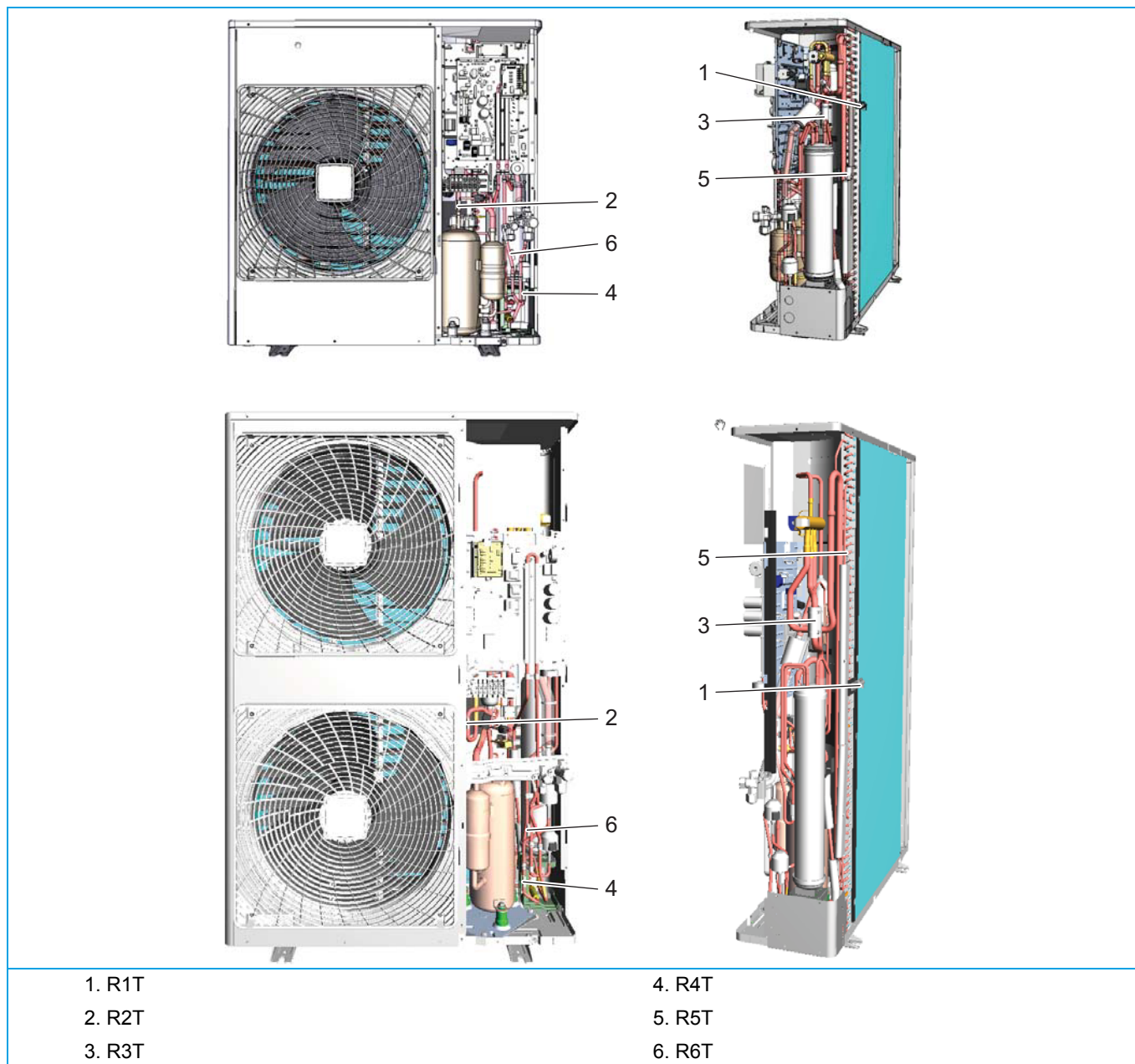

Figure 3-10: Thermistor location



Installation

1. Proceed in reverse order.

3.3.2.3. Replacing 4-way valve body

PRELIMINARY ACTIONS

1. Switch off the Daikin unit via the user interface.
2. Switch off the Daikin unit with the field supplied circuit breaker.
3. Remove plate work when required (refer to "Basic removal" on page 69).
4. Recover the refrigerant (refer to "Refrigerant repair procedures" on page 63).
5. Remove the main PCB (refer to "Replacing main PCB" on page 94).
6. Connect a nitrogen hose to the outdoor suction service port.
7. Attach a hose with core-depressor to allow the release of the nitrogen.

PROCEDURE

Removal

1. Cut the 4-way valve pipes (1).
2. Remove the 4-way valve (2).



CAUTION

The maximum applied Nitrogen pressure must not exceed 0.02 MPa.

3. Supply nitrogen to the piping circuit.
4. Using an oxygen acetylene torch, heat a solder connection of the 4-way valve (2).
5. When the solder material is liquid, pull the 4-way valve pipe (1).
6. Repeat steps 4 and 5 for the 3 remaining 4-way valve pipes (1).
7. Cut the nitrogen supply when the piping has cooled down.

Figure 3-11: Removing 4-way valve body

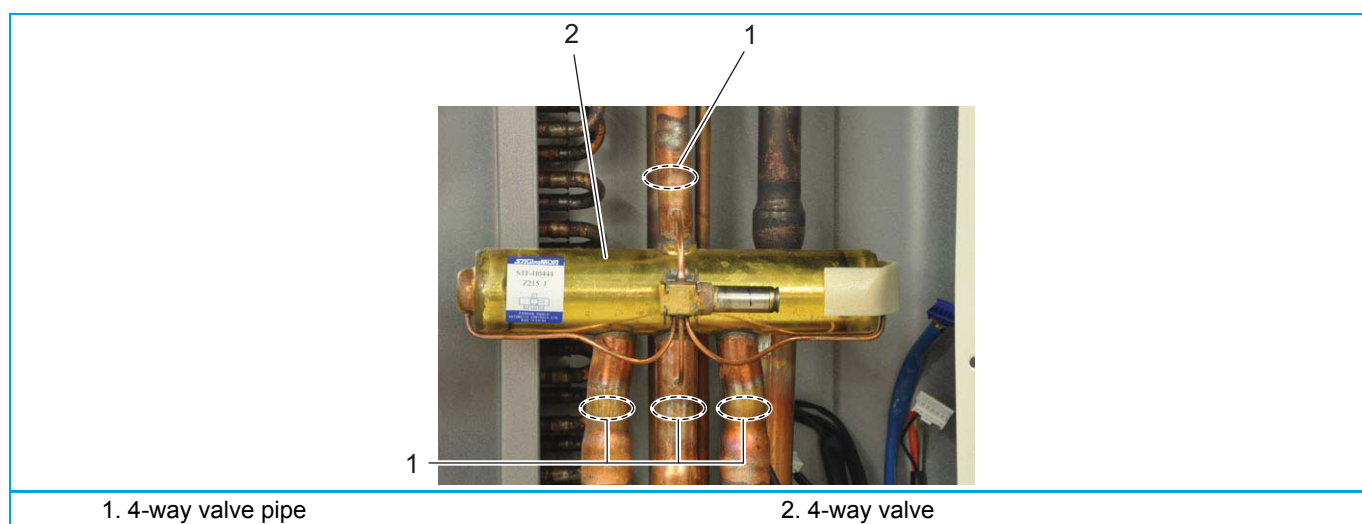

Installation**CAUTION**

Overheating the 4-way valve will damage or destroy it.

**INFORMATION**

Install the putty on the 4-way valve.
Replace all tie wraps that were cut during removal.

1. Wrap a wet rag around the 4-way valve (2).
2. Proceed in reverse order.

3.3.2.4. Replacing 4-way valve coil**PRELIMINARY ACTIONS**

1. Switch off the Daikin unit via the user interface.
2. Switch off the Daikin unit with the field supplied circuit breaker.
3. Remove plate work when required (refer to "[Basic removal](#)" on page 69).

PROCEDURE**Removal**

1. Cut the tie wraps that fix the 4-way valve coil wire.

**WARNING: RISK OF FIRE**

When reconnecting a connector to the PCB, do not apply force, as this may damage the connector or connector pins of the PCB.

2. Unplug the 4-way valve connector from the main PCB.
3. Loosen and remove the screw (1) that fixes the 4-way valve coil (2).
4. Remove the 4-way valve coil (2) from the 4-way valve.

Figure 3-12: Removing 4-way valve body

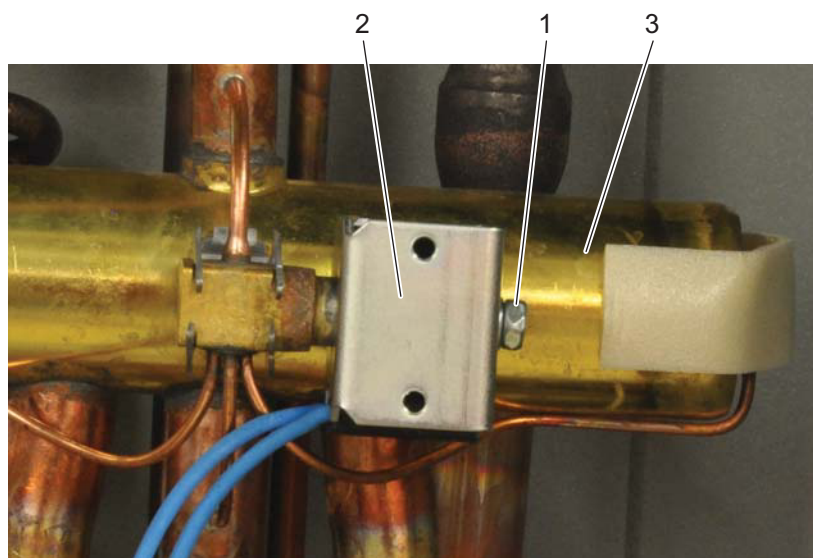

1. Screw

2. 4-way valve coil

Installation**INFORMATION**

Replace all tie wraps that were cut during removal.

1. Proceed in reverse order.

3.3.2.5. Replacing accumulator assembly

Not applicable.

3.3.2.6. Replacing compressor**PRELIMINARY ACTIONS**

1. Switch off the Daikin unit via the user interface.
2. Switch off the Daikin unit with the field supplied circuit breaker.
3. Remove plate work when required (refer to ["Basic removal" on page 69](#)).
4. Recover the refrigerant (refer to ["Refrigerant repair procedures" on page 63](#)).
5. Remove the compressor jacket.
6. Remove the lower propeller fan (refer to ["Replacing propeller fan blade assembly" on page 101](#)).
7. Connect a nitrogen hose to the outdoor suction service port.
8. Attach a hose with core-depressor to allow the release of the nitrogen.

PROCEDURE**Removal**

1. Cut the 2 tie wraps that fix the power and communication wires to the stop valve mounting plate.
2. Loosen and remove the 4 screws (1) that fix the stop valves.

**CAUTION**

The 2 screws that are removed in the next step must be re-installed in the same location upon reassembly.

3. Loosen and remove the 2 screws (2) that fix the stop valve mounting plate (3).
4. Lift and remove the stop valve mounting plate (3).

Figure 3-13: Removing stop valve mounting plate

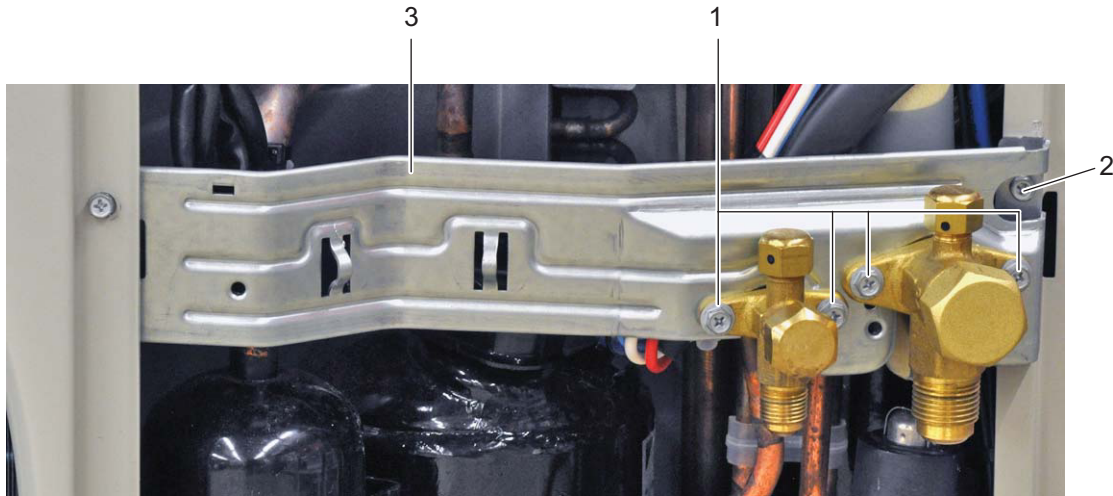

1. Screw

2. Screw

3. Stop valve mounting plate

5. Cut the tie wrap that fixes the R2T thermistor wiring and put the R2T thermistor (2) aside.
6. Put aside the DC fan motor wiring.
7. Remove the terminal cover and unplug the compressor wiring (3).
8. Remove the rubber grommet (6) from the compressor.
9. Cut the compressor pipes (1) below the soldered joint.
10. Loosen and remove the 3 bolts (5) that fix the compressor (7).
11. Remove the compressor (7).
12. Remove the dampers (4) from the compressor (7).
13. Supply nitrogen to the piping circuit.
14. Heat the 2 compressor pipes (1) using an oxygen acetylene torch.
15. When the solder is liquid, remove the 2 compressor pipes (1).
16. Cut the nitrogen supply when the piping has cooled down.

Figure 3-14: Removing compressor

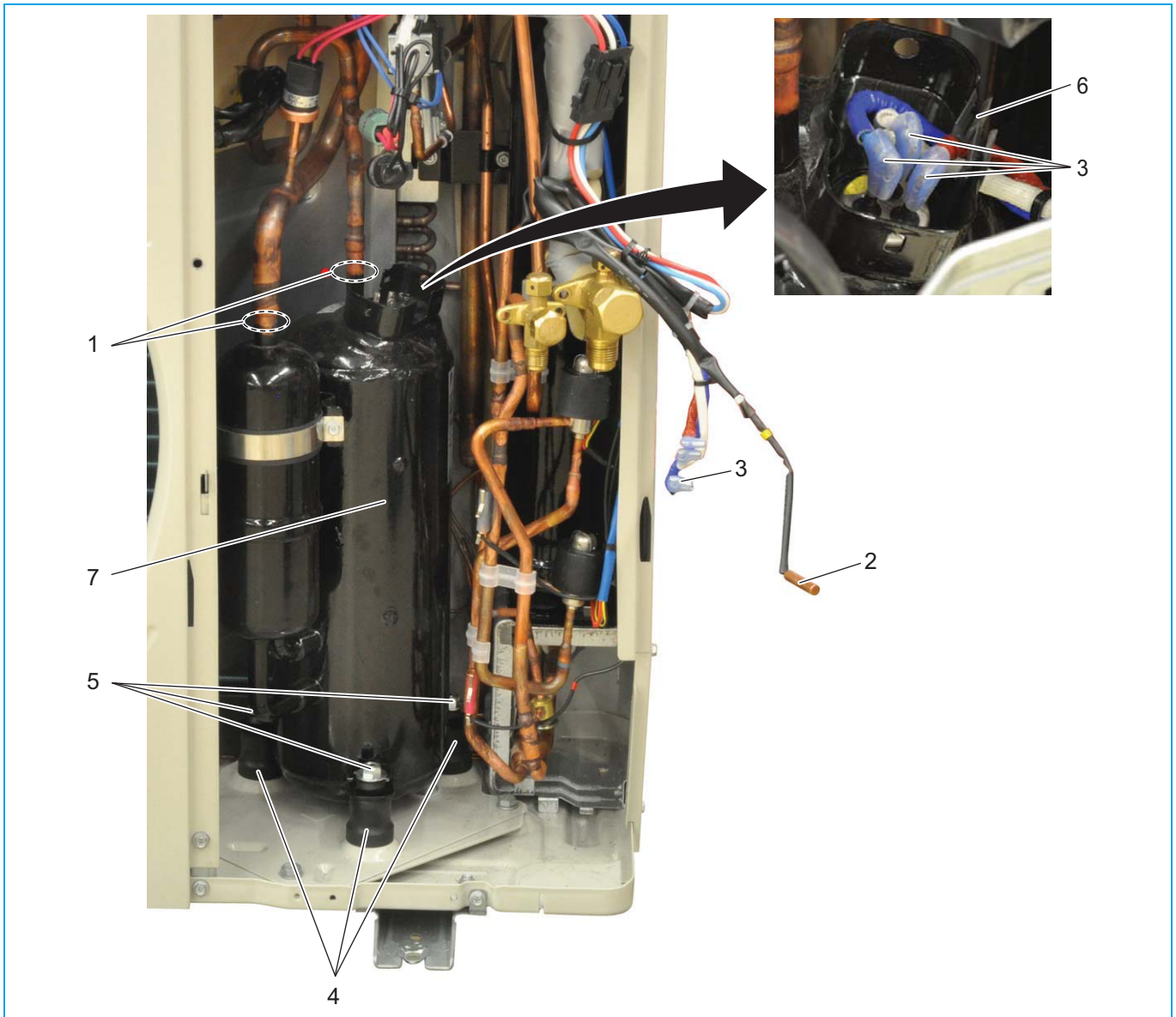

- | | |
|----------------------|-------------------|
| 1. Compressor pipe | 5. Bolt |
| 2. R2T thermistor | 6. Rubber grommet |
| 3. Compressor wiring | 7. Compressor |
| 4. Dampers | |

Installation

	CAUTION
The oil in the compressor is hygroscopic. Remove the caps from the compressor piping as late as possible.	
	INFORMATION
Before installing a new compressor, determine the cause of the compressor failure and take all required corrective actions.	
	INFORMATION
If the dampers are worn, replace the dampers. The bushings inside the dampers are recuperated for use with the new dampers.	
	INFORMATION
Install the compressor sound insulation in the same location.	

1. Check damper status, replace when worn.
2. First install the 3 (new) dampers on the new compressor.
3. When installing the new compressor, remove the caps from the compression pipe and the suction pipe as late as possible.
4. When soldering the compressor pipes, cover the compressor pipes with a wet cloth to prevent overheating the compressor (and the oil in the compression pipe).
5. Proceed in reverse order.

3.3.2.7. Replacing DC fan motor assembly**PRELIMINARY ACTIONS**

1. Switch off the Daikin unit via the user interface.
2. Switch off the Daikin unit with the field supplied circuit breaker.
3. Remove the propeller fan (refer to "[Replacing propeller fan blade assembly](#)" on page 101).

PROCEDURE**Removal**

1. Disconnect the fan connector (1 or 2).
2. Cut the tie wraps (3)
3. Remove the fan motor cable (4) from the cable clamp (5).
4. Guide the fan motor cable (4) through the opening between the partition plate (6) and the stop valve mounting plate (7).
5. Loosen and remove the 4 screws (9) that fix the fan motor (8).
6. Remove the fan motor (8) from the unit.

Figure 3-15: Removing the DC fan motor assembly

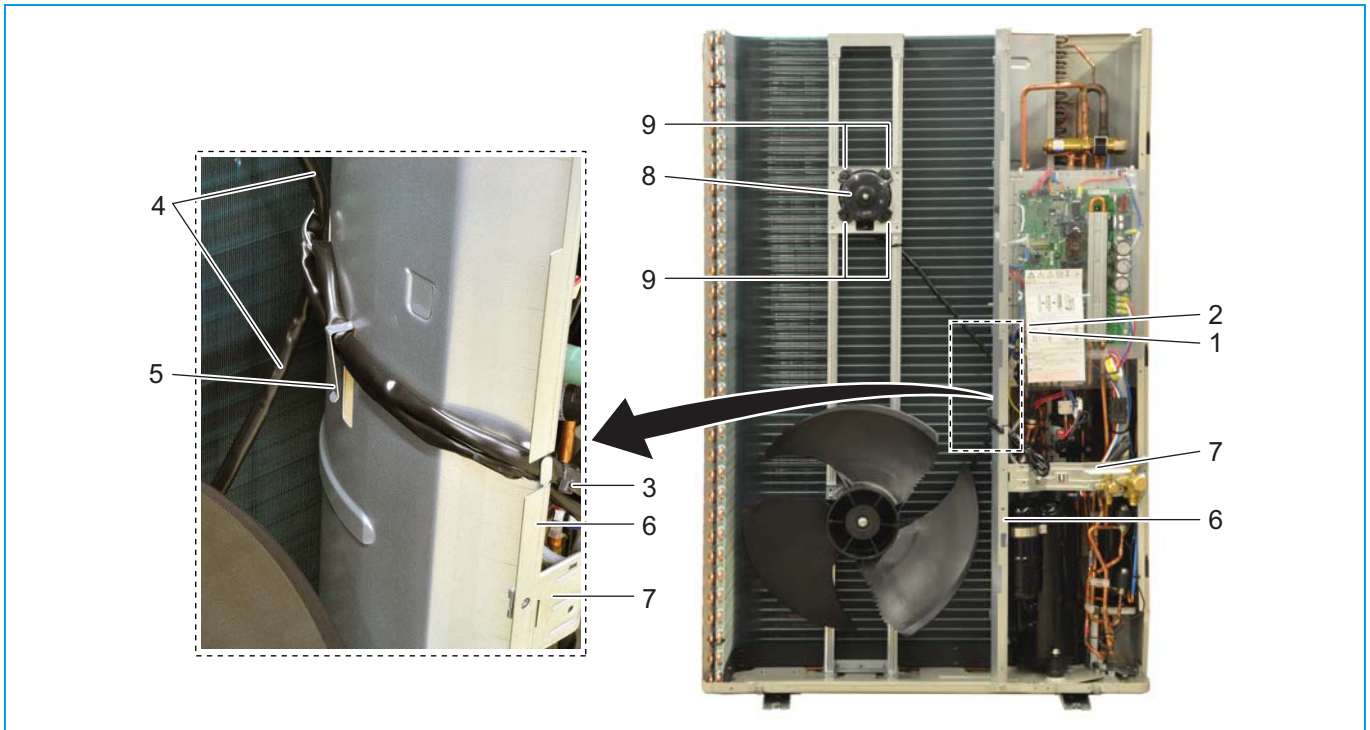

1. Upper fan motor connector
2. Lower fan motor connector
3. Tie wrap
4. Fan motor cable
5. Cable clamp

6. Partition plate
7. Stop valve mounting plate
8. Fan motor
9. Screw

Installation

1. Proceed in reverse order.



CAUTION

Plug in the fan connector before installing the plate work (this allows to trace the DC fan motor wiring).
Do not swap DC fan motor connections (main PCB: upper connector = M2F = lower fan, lower connector = M1F = upper fan).

3.3.2.8. Replacing electrical noise filter

PRELIMINARY ACTIONS

1. Switch off the Daikin unit via the user interface.
2. Switch off the Daikin unit with the field supplied circuit breaker.
3. Remove the main PCB assy (refer to ["Replacing main PCB" on page 94](#)).

PROCEDURE 1-PHASE

Removal



WARNING: RISK OF FIRE

When reconnecting a connector to the PCB, do not apply force, as this may damage the connector or connector pins of the PCB.

1. Unplug the connectors (2, 4, 5).
2. Remove the wiring from the screw terminals (1, 3).

3. Unplug the ground wires (6).
4. Unlock the 9 standoffs (8) that fix the electrical noise filter PCB.
5. Remove the electrical noise filter PCB (7) from the main PCB assembly.

Figure 3-16: Removing the electrical noise filter (1-phase)

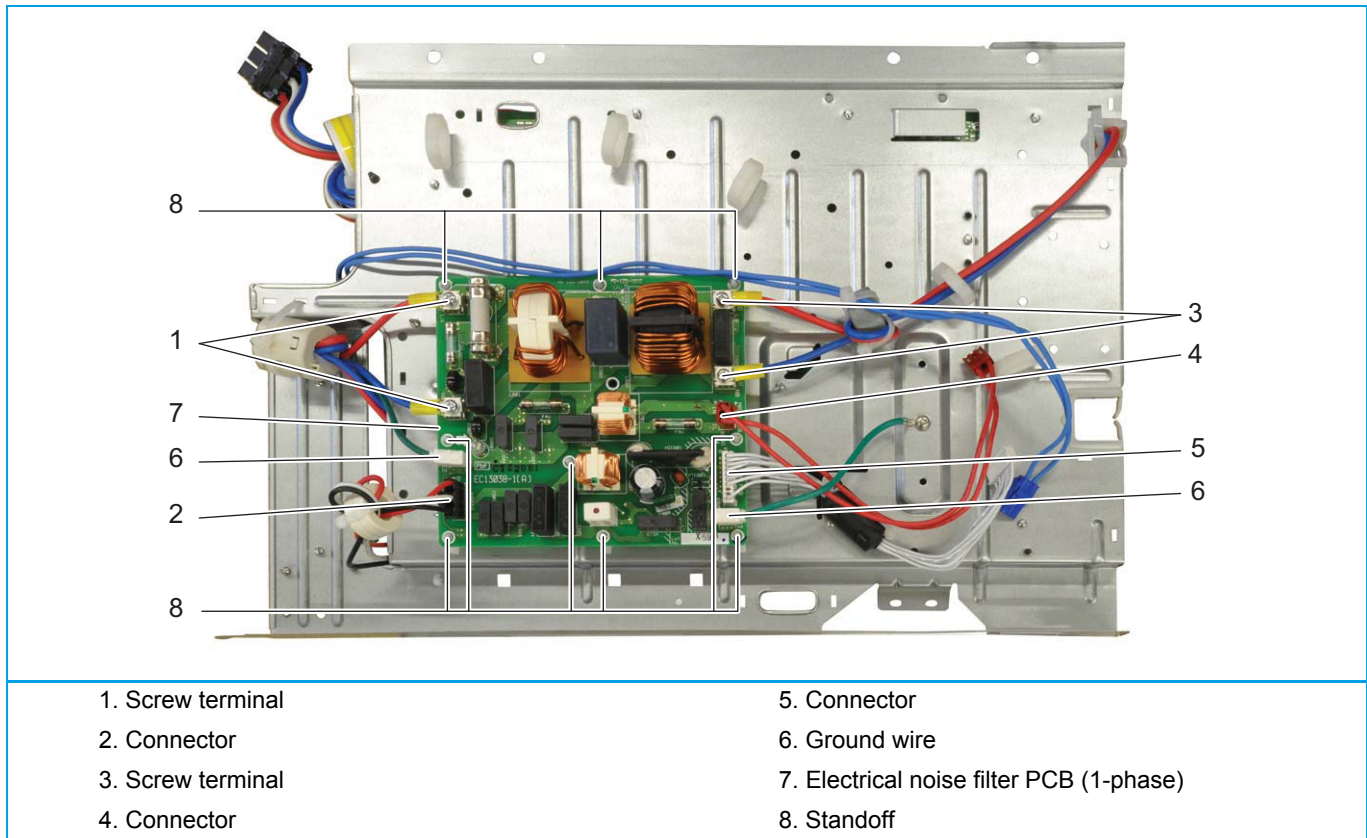

Installation



INFORMATION

Replace all tie wraps that were cut during removal.

1. Proceed in reverse order.

PROCEDURE 3-PHASE

Removal



WARNING: RISK OF FIRE

When reconnecting a connector to the PCB, do not apply force, as this may damage the connector or connector pins of the PCB.

1. Unplug the connector (2).
2. Unplug the terminal wires (1).
3. Unplug the 4 terminal wires (blue, black, red, white), fixed at the left side of the PCB, at the side of the main PCB.
4. Unplug the ground wire (3) at the side of the main PCB.
5. Remove the wiring from the cable clamps (6) if necessary.
6. Unlock the 4 standoffs (5) that fix the electrical noise PCB (4).

- Remove the electrical noise filter PCB (4) from the main PCB assembly.

Figure 3-17: Removing the electrical noise filter (3-phase)

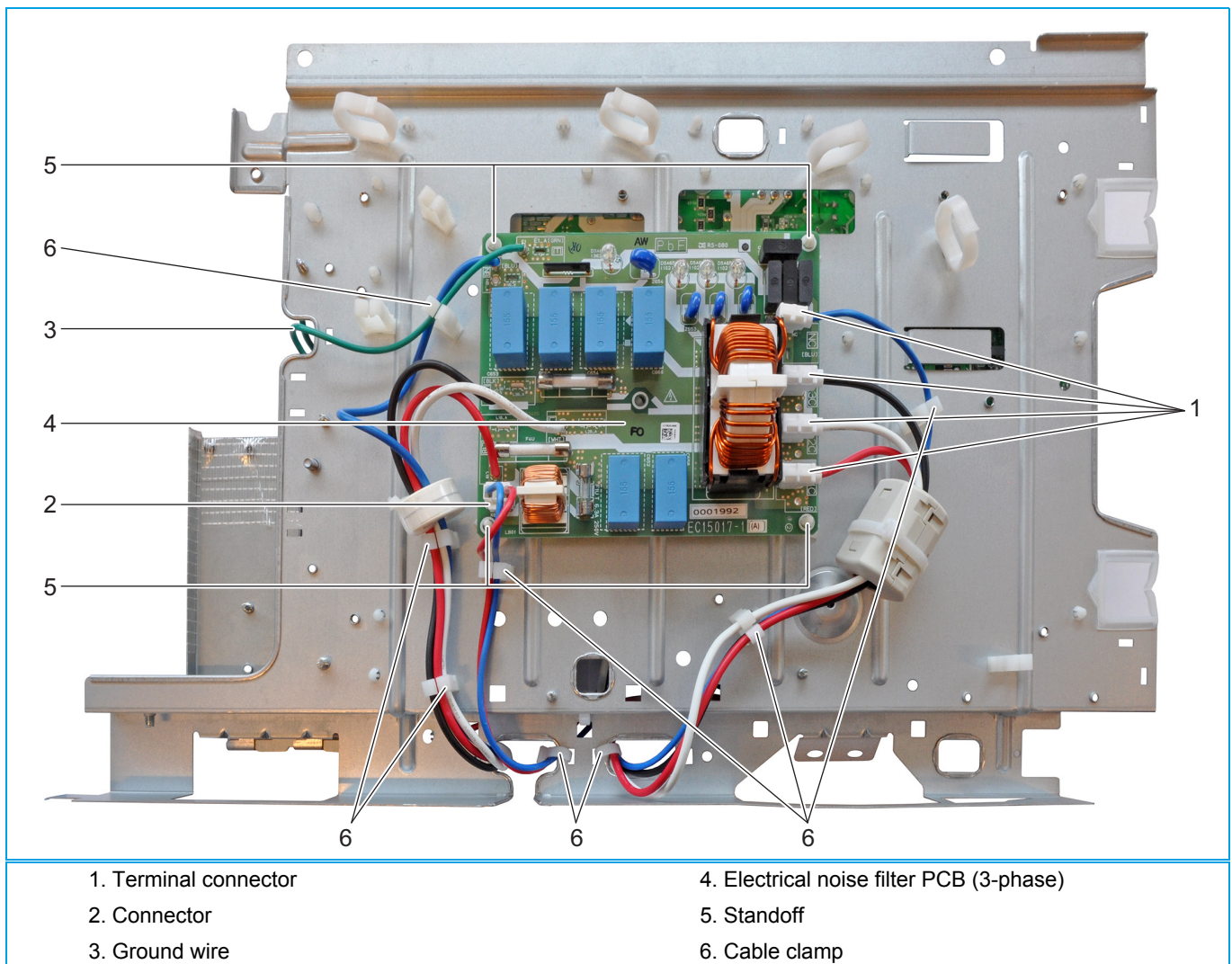

Installation



INFORMATION

Replace all tie wraps that were cut during removal.

- Proceed in reverse order.

3.3.2.9. Replacing expansion valve body

PRELIMINARY ACTIONS

- Switch off the Daikin unit via the user interface.
- Switch off the Daikin unit with the field supplied circuit breaker.
- Remove plate work when required (refer to ["Basic removal" on page 69](#)).
- Recover the refrigerant (refer to ["Refrigerant repair procedures" on page 63](#)).
- Remove the expansion valve motor (refer to ["Replacing expansion valve motor" on page 87](#)).
- Connect a nitrogen hose to the outdoor suction service port.
- Attach a hose with core-depressor to allow the release of the nitrogen.

PROCEDURE**Removal**

1. Cut the 2 expansion valve pipes (1).
2. Remove the expansion valve (2).

**CAUTION**

The maximum applied Nitrogen pressure must not exceed 0.02 MPa.

3. Supply nitrogen to the piping circuit.
4. Using an oxygen acetylene torch, heat the 2 expansion valve pipes (1).
5. When the solder material is liquid, pull the 2 expansion valve pipes (1).
6. Cut the nitrogen supply when the piping has cooled down.

Figure 3-18: Removing expansion valve

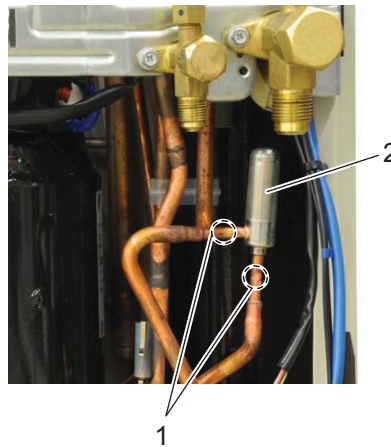

1. Expansion valve pipe

2. Expansion valve

Installation

1. Wrap a wet rag around the expansion valve Y1E (3).

**WARNING**

Overheating the expansion valve Y1E will damage or destroy it.

2. Proceed in reverse order.

3.3.2.10. Replacing expansion valve motor

PRELIMINARY ACTIONS

1. Switch off the Daikin unit via the user interface.
2. Switch off the Daikin unit with the field supplied circuit breaker.
3. Remove plate work when required (refer to "Basic removal" on page 69).

PROCEDURE

Removal

1. Turn the expansion valve Y1E motor (1) 1/8th turn counter clockwise to unlock it.
2. Remove the expansion valve Y1E motor (1) from the expansion valve Y1E (2).
3. Cut all tie wraps that fix the expansion valve motor wiring.



WARNING: RISK OF FIRE

When reconnecting a connector to the PCB, do not apply force, as this may damage the connector or connector pins of the PCB.

4. Unplug the expansion valve motor connector from the Main PCB.

Figure 3-19: Removing expansion valve motor

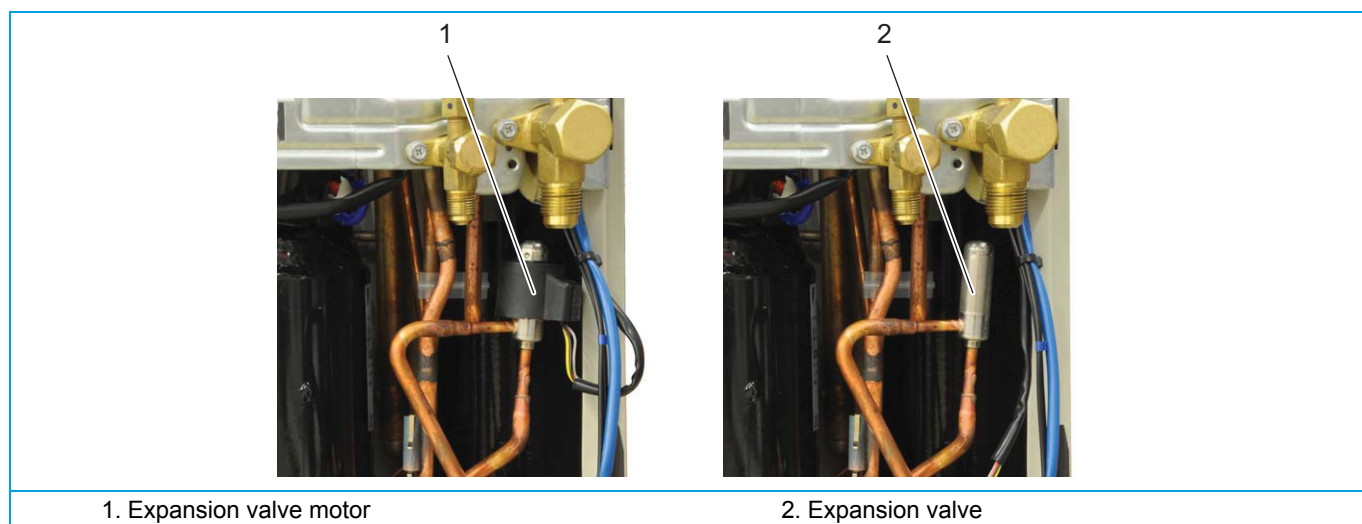

Installation



INFORMATION

Replace all tie wraps that were cut during removal.

1. Proceed in reverse order.
2. When installing the expansion valve motor (1), lock it on the expansion valve (2).

Figure 3-20: Removing expansion valve motor

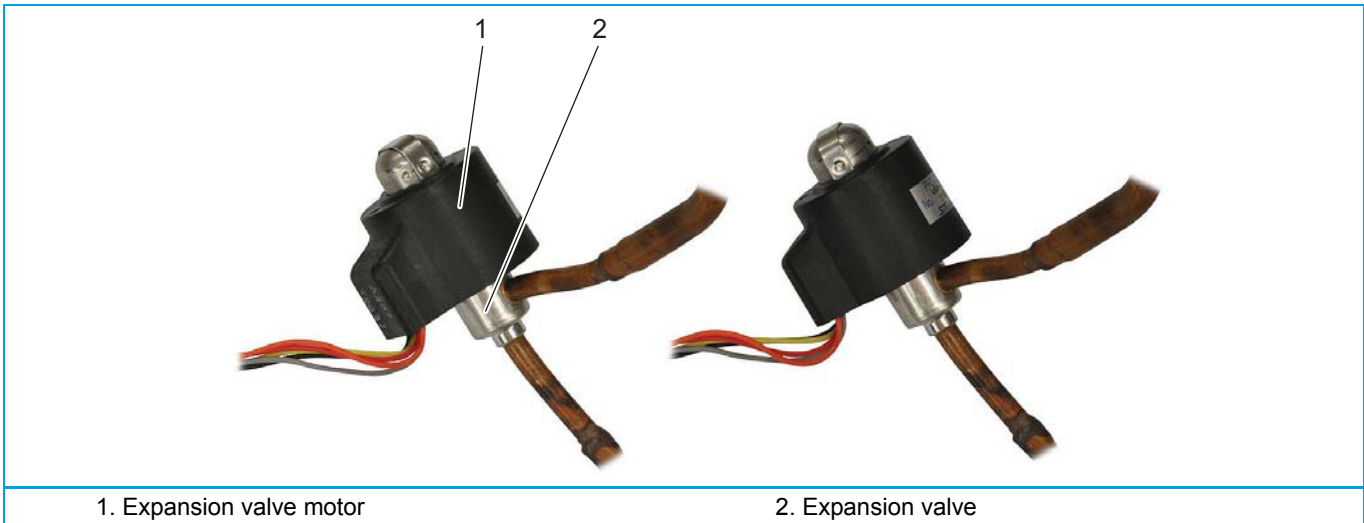

3.3.2.11. Replacing solenoid valve

PRELIMINARY ACTIONS

1. Switch off the Daikin unit via the user interface.
2. Switch off the Daikin unit with the field supplied circuit breaker.
3. Remove plate work when required (refer to ["Basic removal" on page 69](#)).
4. Recover the refrigerant (refer to ["Refrigerant repair procedures" on page 63](#)).
5. Connect a nitrogen hose to the outdoor suction service port.
6. Attach a hose with core-depressor to allow the release of the nitrogen.
7. Remove the solenoid valve coil (refer to ["Replacing solenoid valve coil" on page 90](#)).
8. Connect a nitrogen hose to the outdoor suction service port.
9. Attach a hose with core-depressor to allow the release of the nitrogen.

PROCEDURE

Removal

1. Cut the 2 solenoid valve pipes (1).
2. Remove the solenoid valve (2).



CAUTION

The maximum applied Nitrogen pressure must not exceed 0.02 MPa.

3. Supply nitrogen to the piping circuit.
4. Using an oxygen acetylene torch, heat the 2 solenoid valve pipes (1).
5. When the solder material is liquid, pull the 2 solenoid valve pipes (1).
6. Cut the nitrogen supply when the piping has cooled down.

Figure 3-21: Removing solenoid valve

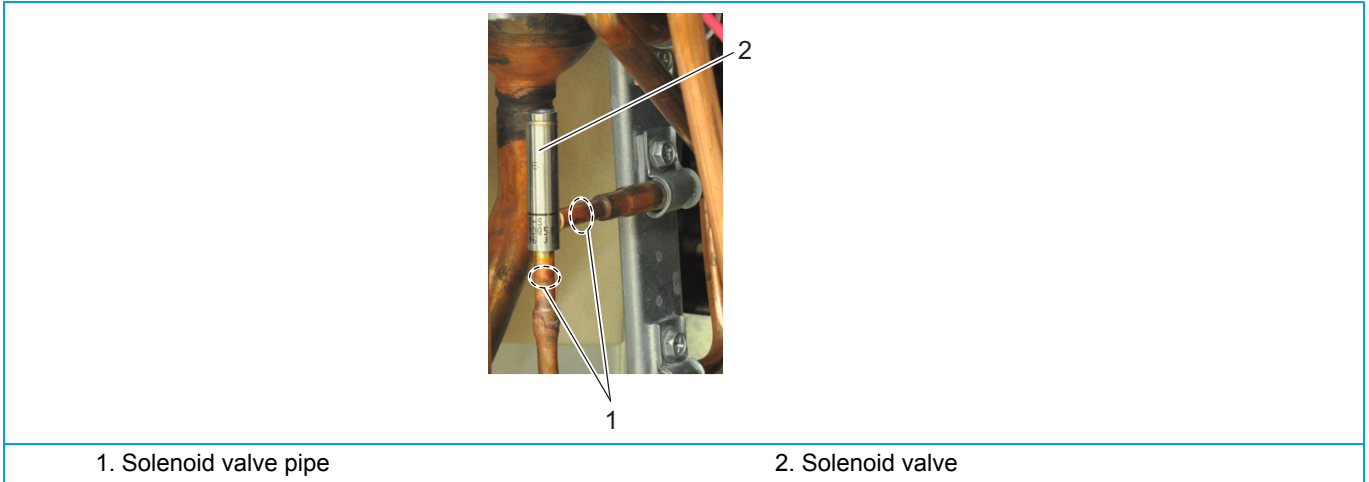

Installation

1. Wrap a wet rag around the solenoid valve.

	<p>WARNING Overheating the solenoid valve will damage or destroy it.</p>
--	---

2. Proceed in reverse order.

3.3.2.12. Replacing solenoid valve coil

PRELIMINARY ACTIONS

1. Switch off the Daikin unit via the user interface.
2. Switch off the Daikin unit with the field supplied circuit breaker.
3. Remove plate work when required (refer to "Basic removal" on page 69).
4. Recover the refrigerant (refer to "Refrigerant repair procedures" on page 63).
5. Connect a nitrogen hose to the outdoor suction service port.
6. Attach a hose with core-depressor to allow the release of the nitrogen.

PROCEDURE

Removal

1. Loosen and remove the screw (1) that fixes the solenoid valve coil (2) to the solenoid valve (3).
2. Remove the solenoid valve coil (2) from the solenoid valve (3).
3. Cut tie wraps that fix the solenoid valve coil (2) wiring.



WARNING: RISK OF FIRE

When reconnecting a connector to the PCB, do not apply force, as this may damage the connector or connector pins of the PCB.

4. Unplug the solenoid valve coil connector from the Main PCB.

Figure 3-22: Removing solenoid valve coil

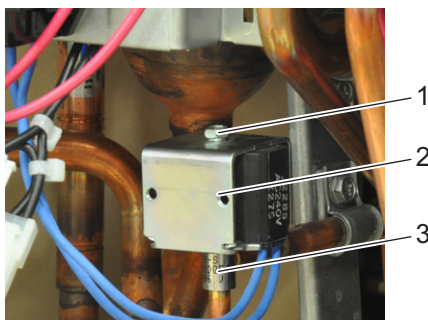

1. Screw

2. Solenoid valve coil

3. Solenoid valve

Installation



INFORMATION

Replace all tie wraps that were cut during removal.

1. Proceed in reverse order.

3.3.2.13. Replacing high pressure switch

PRELIMINARY ACTIONS

1. Switch off the Daikin unit via the user interface.
2. Switch off the Daikin unit with the field supplied circuit breaker.
3. Remove plate work when required (refer to "Basic removal" on page 69).
4. Recover the refrigerant (refer to "Refrigerant repair procedures" on page 63).
5. Connect a nitrogen hose to the outdoor suction service port.
6. Attach a hose with core-depressor to allow the release of the nitrogen.

PROCEDURE

Removal

1. Unplug the high pressure switch connector.
2. Cut the tie wrap.
3. Cut the high pressure switch S1PH pipe.
4. Remove the high pressure switch (1).



CAUTION

The maximum applied Nitrogen pressure must not exceed 0.02 MPa.

5. Supply nitrogen to the piping circuit.
6. Heat the pressure switch pipe using an oxygen acetylene torch.
7. When the solder is liquid, pull the pressure sensor pipe.
8. Cut the nitrogen supply when the piping has cooled down.

Figure 3-23: Removing high pressure switch

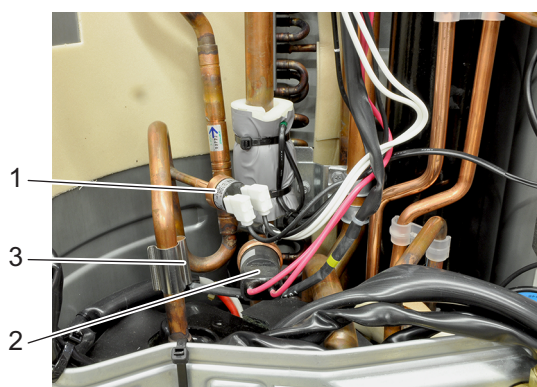

1. High pressure switch
2. Low pressure switch

3. Compressor discharge thermistor

Installation**CAUTION**

Overheating the high pressure sensor will damage or destroy it.

1. Wrap a wet rag around the pressure sensor.
2. Proceed in reverse order.

3.3.2.14. Replacing inverter PCB

The inverter is integrated in the main PCB, see ["Replacing main PCB" on page 94](#).

3.3.2.15. Replacing low pressure switch**PRELIMINARY ACTIONS**

1. Switch off the Daikin unit via the user interface.
2. Switch off the Daikin unit with the field supplied circuit breaker.
3. Remove plate work when required (refer to ["Basic removal" on page 69](#)).
4. Recover the refrigerant (refer to ["Refrigerant repair procedures" on page 63](#)).
5. Connect a nitrogen hose to the outdoor suction service port.
6. Attach a hose with core-depressor to allow the release of the nitrogen.

PROCEDURE**Removal**

1. Unplug the low pressure switch connector on the main PCB.
2. Cut the tie wrap that fixes the low pressure switch wiring.
3. Cut the low pressure switch pipe.
4. Remove the low pressure switch (2).

**CAUTION**

The maximum applied Nitrogen pressure must not exceed 0.02 MPa.

5. Supply nitrogen to the piping circuit.
6. Heat the low pressure switch pipe using an oxygen acetylene torch.
7. When the solder is liquid, pull the low pressure switch pipe.
8. Cut the nitrogen supply when the piping has cooled down.

Figure 3-24: Removing low pressure switch

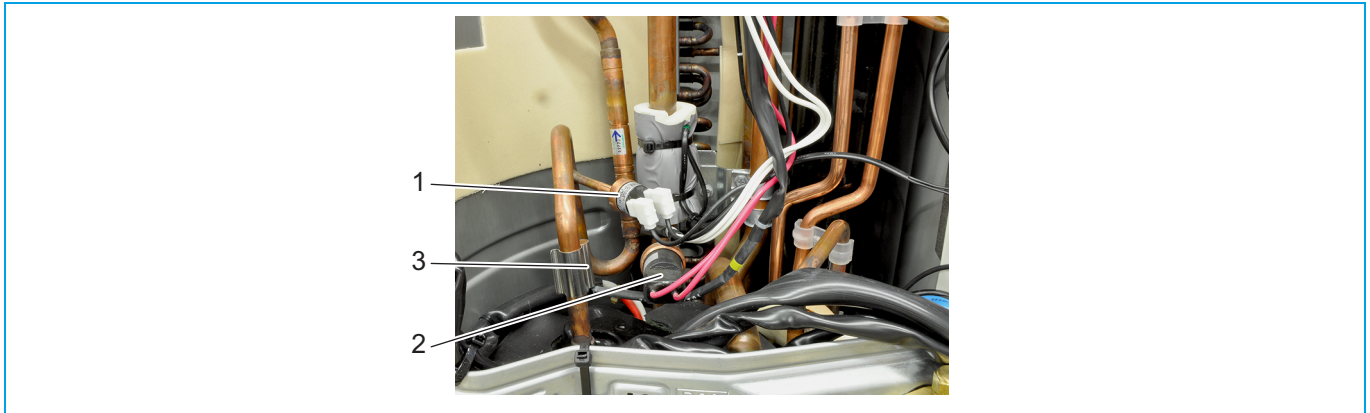

- 1. High pressure switch
- 2. Low pressure switch

3. Compressor discharge thermistor

Installation

Figure 3-25: Installation



CAUTION

Overheating the low pressure switch will damage or destroy it.

1. Wrap a wet rag around the low pressure switch.
2. Proceed in reverse order.

3.3.2.16. Replacing main PCB

PRELIMINARY ACTIONS

1. Switch off the Daikin unit via the user interface.
2. Switch off the Daikin unit with the field supplied circuit breaker.
3. Remove plate work when required (refer to ["Basic removal" on page 69](#)).

PROCEDURE 1-PHASE

Removal

First, remove Main PCB assembly:

1. Flip over the protection sheet.
2. Remove the power and remote control wiring from the terminal block (1).
3. Cut the 5 tie wraps.



WARNING: RISK OF FIRE

When reconnecting a connector to the PCB, do not apply force, as this may damage the connector or connector pins of the PCB.

4. Unplug all connectors (2) from the main PCB (4).
5. Unplug the ground wire (8).
6. Remove the 4-way valve coil from the 4-way valve (refer to ["Replacing 4-way valve coil" on page 78](#)).
7. Remove the wiring from the cable clamp.
8. Remove the 2 screws (6) that fix the heat sink with a ring spanner or a wrench/socket.



CAUTION

Due to the large size of the PCB it is sensitive to bending.
Only use a wrench/socket or a ring spanner to loosen or fasten the heat sink screws.
Do not use a screwdriver.

9. Remove the screws (3) that fix the main PCB support to the Daikin unit (some screws are not visible).
10. Lift and turn the lid (5) to the left.



CAUTION

Do not remove the main PCB assembly yet, it is still attached by wiring.

11. Lift the main PCB (4) to release it from the unit.



CAUTION

Tilting the main PCB stresses the heat pipe, do not tilt more than 15°.

12. Slightly tilt (max. 15°) the main PCB (4) and disconnect 2 connectors at the rear of the main PCB panel.
13. Guide the wiring through the slots.

Figure 3-26: Removing the main PCB assembly (1-phase)

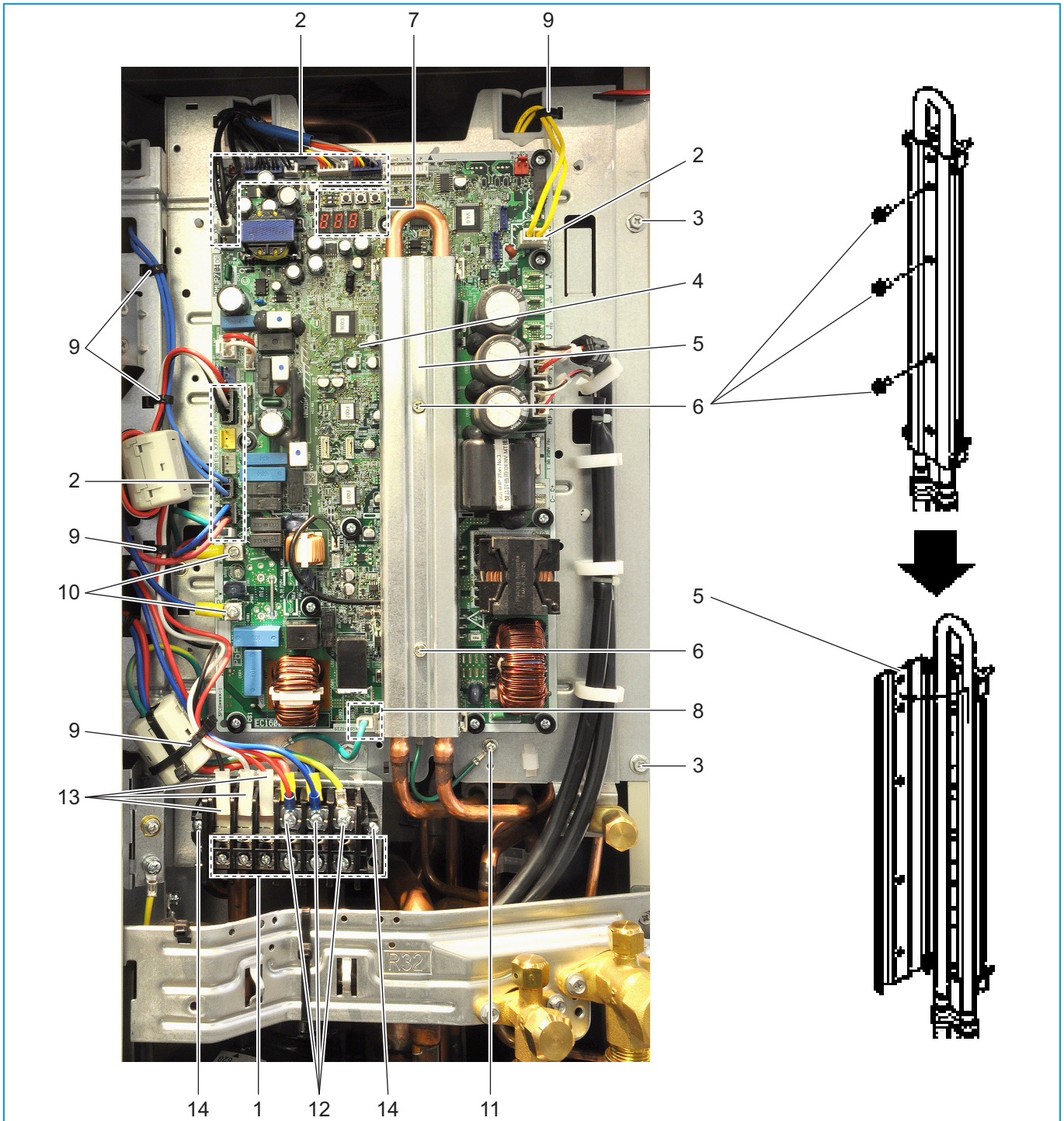

- | | |
|----------------------|----------------|
| 1. Terminal block | 8. Ground wire |
| 2. Connectors | 9. Tie wrap |
| 3. Screw | 10. Screw |
| 4. Main PCB 1-phase | 11. Screw |
| 5. Lid | 12. Screw |
| 6. Screw | 13. Plug |
| 7. 7-segment display | 14. Screw |

Secondly, strip the Main PCB assembly (front)

14. Cut the tie wraps that fix the protection sheet; remove the protection sheet (not visible).

15. Cut the tie wrap (9).

16. Loosen and remove the 2 screws (10) that fix the wiring.
17. Loosen and remove the screw (11) that fix the wiring.
18. Loosen and remove the 3 screws (12) that fix the wiring.
19. Disconnect the 3 connectors (13) from the terminal block.
20. Loosen and remove the 2 screws (14) that fix the terminal block.

Finally, strip the Main PCB assembly (rear)

21. Loosen and remove the 2 screws (1) that fix the wiring.
22. Cut the 2 tie wraps (2) that fix the wiring.
23. Unlock the 9 standoffs (3) that fix the electrical noise filter PCB.
24. Remove the wiring from the cable clamp (4).
25. Remove the electrical noise filter PCB (5).

Figure 3-27: Stripping the main PCB assembly 1-phase (rear)

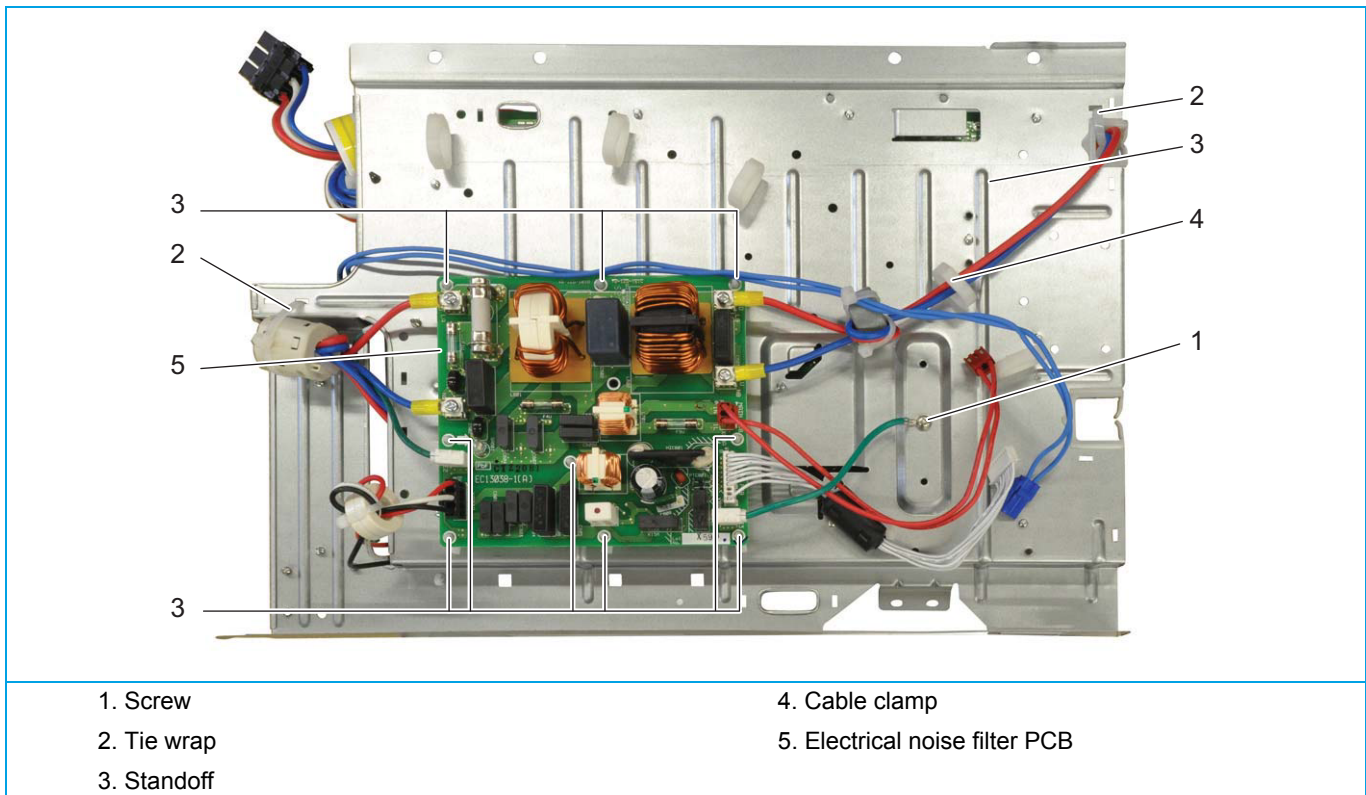

Installation

1. Proceed in reverse order.

PROCEDURE 3-PHASE**Removal**

First, remove Main PCB assembly:

1. Flip over the protection sheet.
2. Remove the power and remote control wiring from the terminal block (1).
3. Cut the tie wraps.

**WARNING: RISK OF FIRE**

When reconnecting a connector to the PCB, do not apply force, as this may damage the connector or connector pins of the PCB.

4. Unplug all connectors (2) from the main PCB (4).
5. Remove the 4-way valve coil from the 4-way valve (refer to ["Replacing 4-way valve coil" on page 78](#)).
6. Remove the wiring from the cable clamp.
7. Remove the 2 screws (6) that fix the heat sink with a ring spanner or a wrench/socket.

**CAUTION**

Due to the large size of the PCB it is sensitive to bending.
Only use a wrench/socket or a ring spanner to loosen or fasten the heat sink screws.
Do not use a screwdriver.

8. Remove the screws (3) that fix the main PCB support to the Daikin unit (some screws are not visible).
9. Lift and turn the lid (5) to the left.

**CAUTION**

Do not remove the main PCB assembly yet, it is still attached by wiring.

10. Lift the main PCB (1) to release it from the unit.

**CAUTION**

Tilting the main PCB stresses the heat pipe, do not tilt more than 15°.

11. Slightly tilt (max. 15°) the main PCB (4) and disconnect 2 connectors at the rear of the main PCB panel.
12. Guide the wiring through the slots.

Figure 3-28: Removing the main PCB assembly (3-phase)

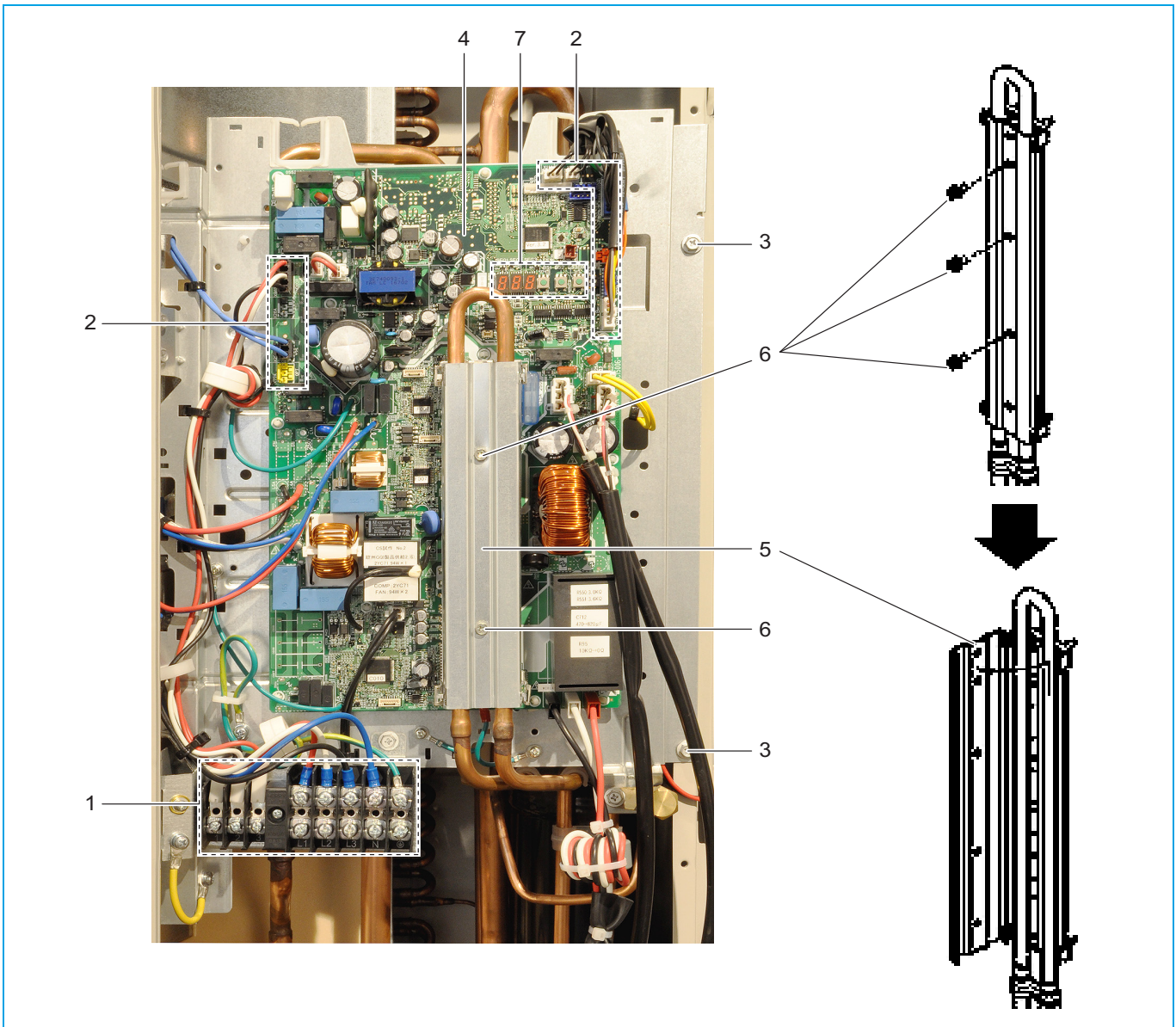

- | | |
|---------------------|----------------------|
| 1. Terminal block | 5. Lid |
| 2. Connectors | 6. Screw |
| 3. Screw | 7. 7-segment display |
| 4. Main PCB 3-phase | |

Secondly, strip the Main PCB assembly (front)

13. Cut the tie wraps that fix the protection sheet; remove the protection sheet.
14. Cut the tie wrap.
15. Loosen and remove the screws (1) that fix the ground wiring.
16. Loosen and remove the screws (2) that fix the 4 terminal wires (blue, black, red, white).
17. Disconnect the 3 terminal connectors (3) from the terminal block.
18. Loosen and remove the screws that fix the terminal block.

Figure 3-29: Stripping the main PCB assembly 3-phase (front)

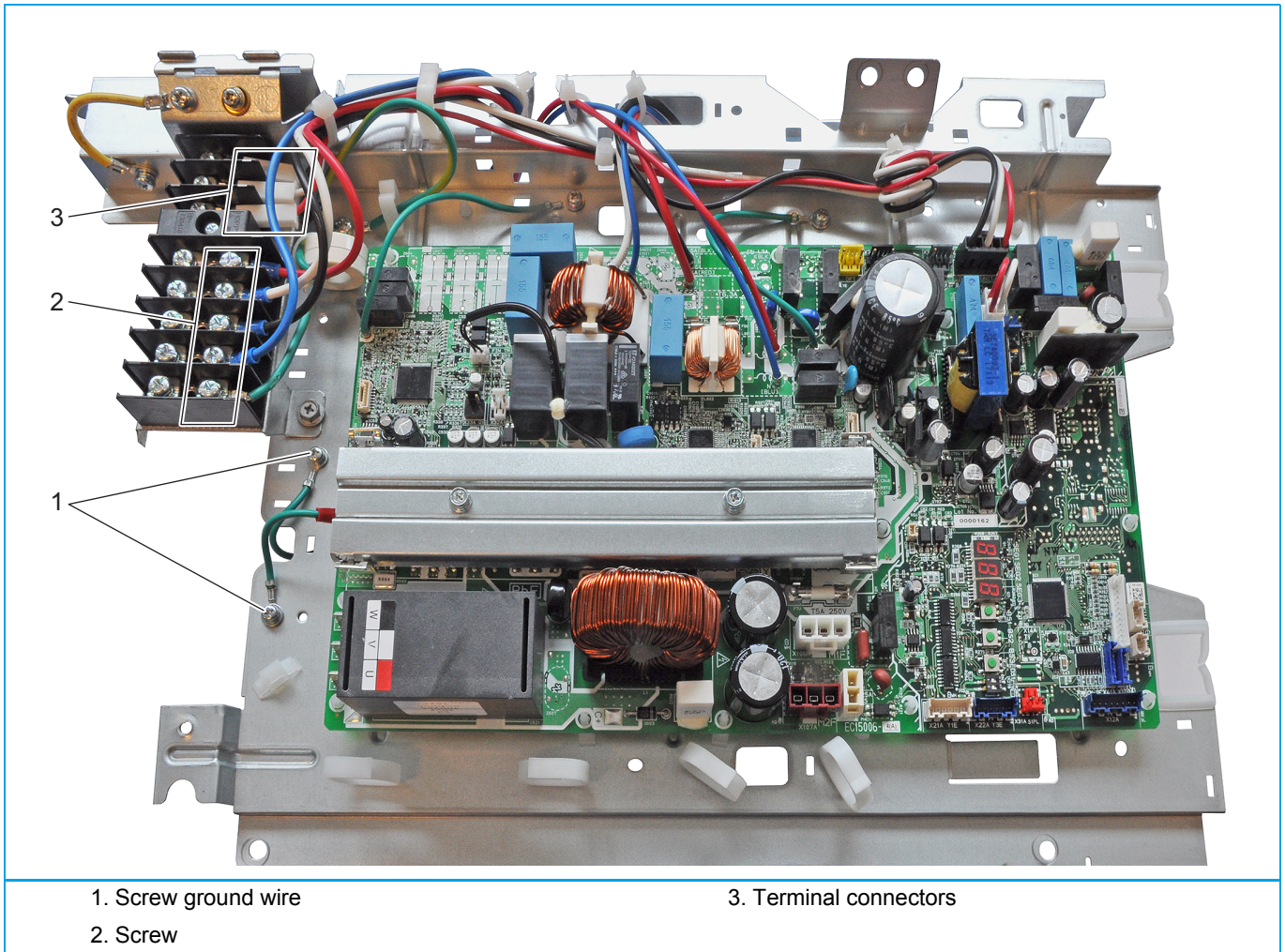

Finally, strip the Main PCB assembly (rear)

19. Unplug the connector (2).
20. Unplug the terminal wires (1).
21. Remove the wiring from the cable clamps (6) if necessary.
22. Unlock the 4 standoffs (5) that fix the electrical noise PCB (4).
23. Remove the electrical noise filter PCB (4) from the main PCB assembly.

Figure 3-30: Stripping the main PCB assembly 3-phase (rear)

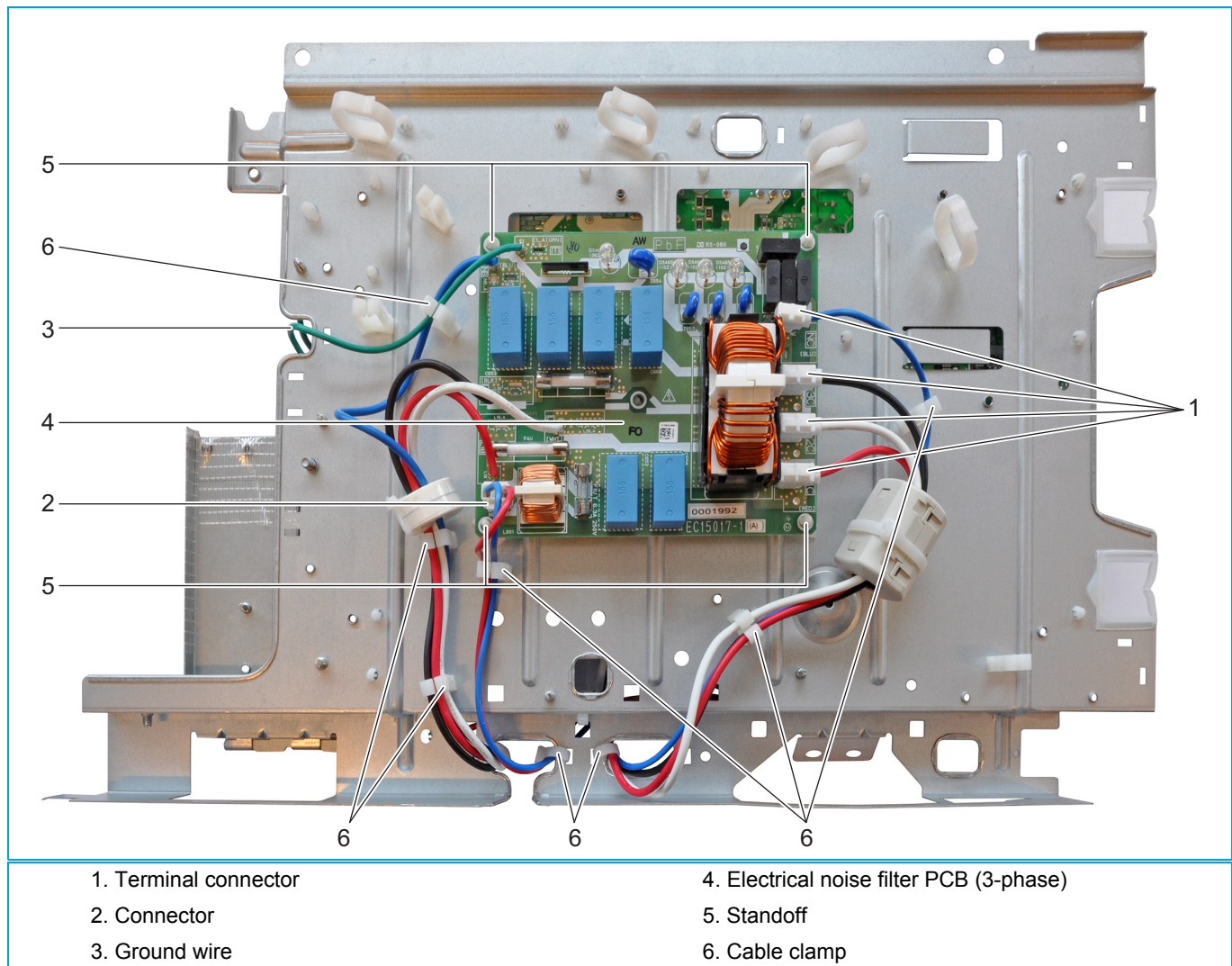

Installation

1. Proceed in reverse order.

3.3.2.17. Replacing propeller fan blade assembly

PRELIMINARY ACTIONS

1. Switch off the Daikin unit via the user interface.
2. Switch off the Daikin unit with the field supplied circuit breaker.

PROCEDURE

Removal

1. Loosen and remove the 4 nuts (1) that fix the air discharge grill (2).
2. Press (A) the 2 latches to release the air discharge grill (2).
3. Tilt (B) the air discharge grill (2) and remove it from the Daikin unit.
4. Remove the nut (3) that fixes the propeller fan (4).
5. Pull the propeller fan blade assembly (2) from the fan motor (5).

Figure 3-31: Removing the propeller fan blade assembly

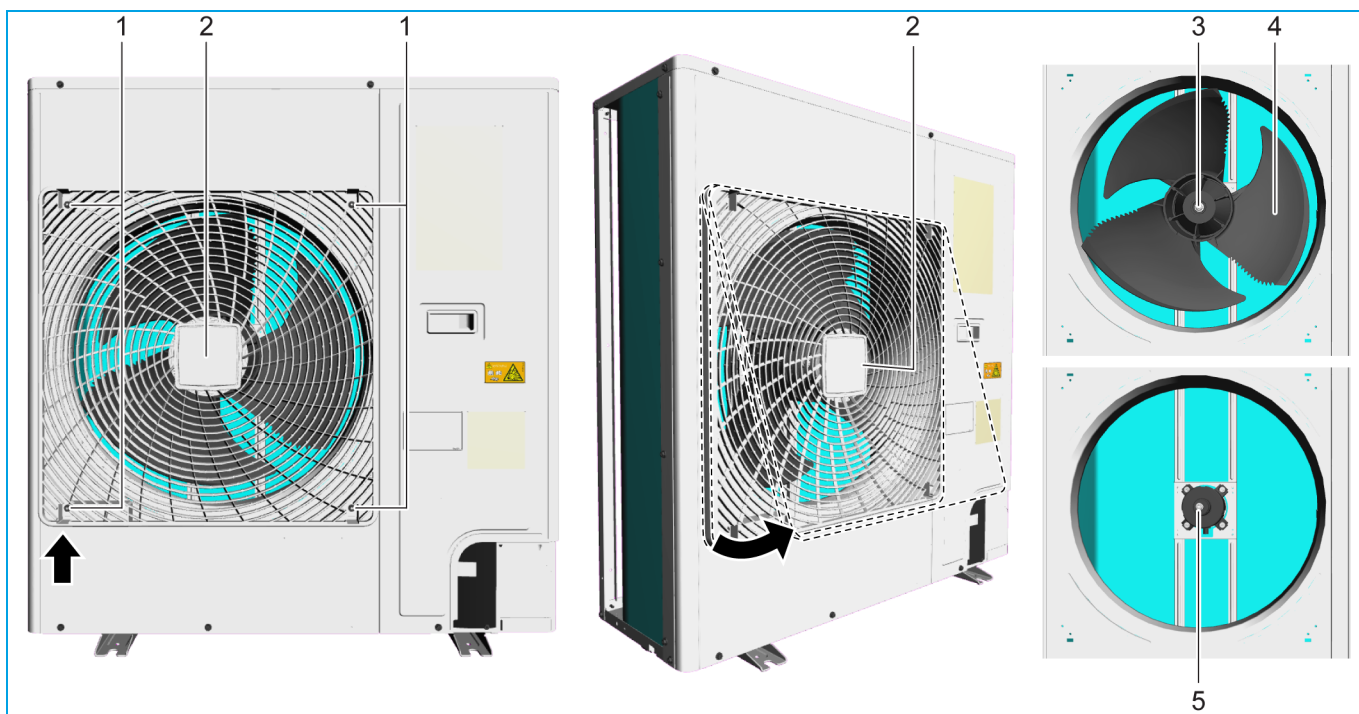

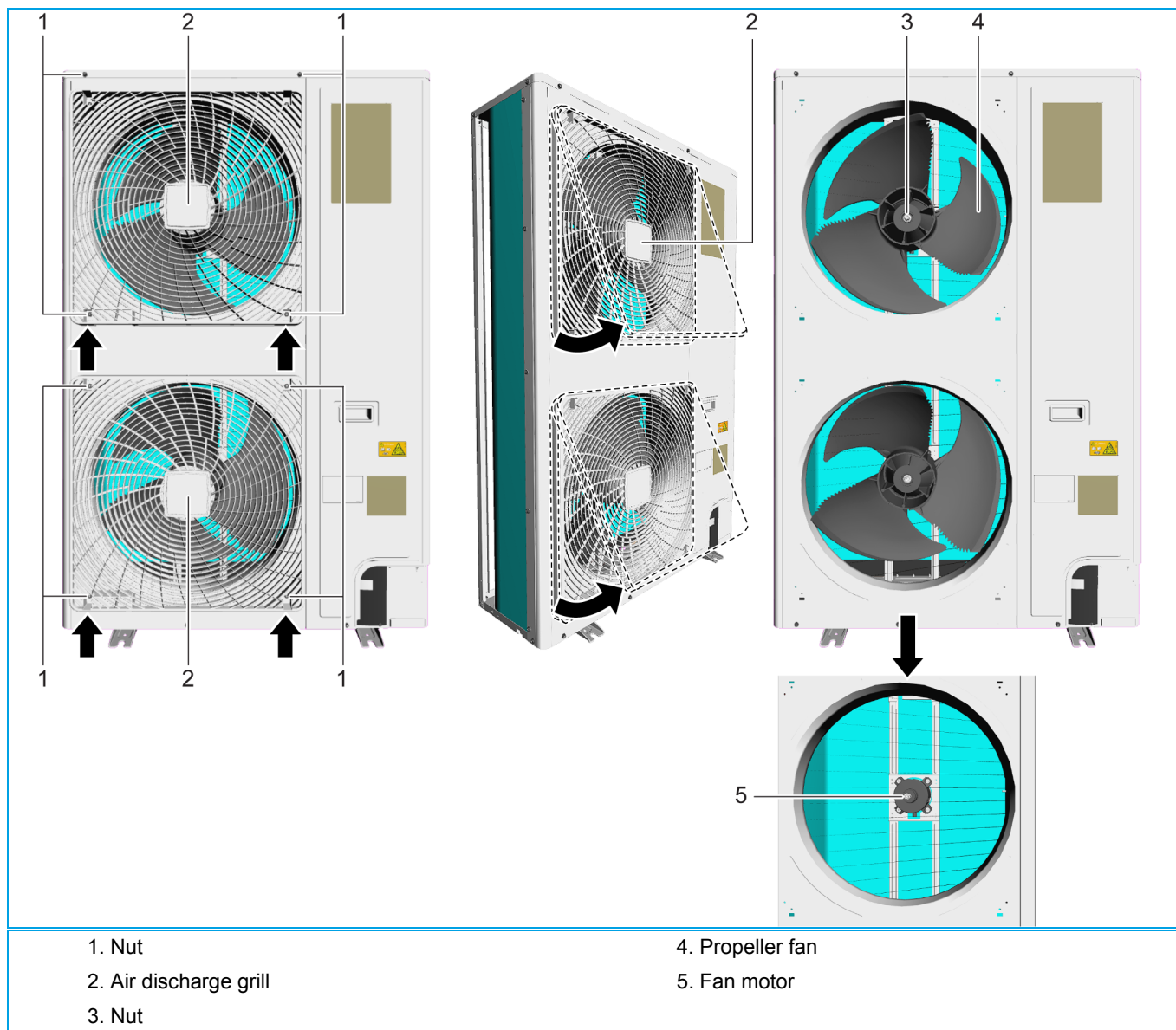

Part 4. Maintenance

This part contains the following chapters:

Indoor unit	103
Outdoor unit.....	104

4.1. Indoor unit

4.1.1. General maintenance indoor unit

1. Optimal operation conditions

	Cooling	Heating
Differential between suction temperature and discharge temperature	8~18°C	14~30°C
DB	27°C	20°C
WB	19°C	Not applicable

2. Correlation of air-conditioner's operation status, pressure and running current

COOLING	Low pressure	High pressure	Running current
Dirty air filter	Lower	Lower	Lower
Short circuit of air inlet/outlet	Lower	Lower	Lower
Air mixed in refrigerant	Higher	Higher	Higher
Water mixed in refrigerant	Lower*	Lower	Lower
Dirt mixed in refrigerant	Lower**	Lower	Lower
Refrigerant shortage (gas)	Lower	Lower	Lower
Unsatisfactory compression	Higher***	Lower	Lower

* Water in the refrigerant freezes inside the electronic expansion valve and is basically the same phenomenon as pump down.

** Dirt in the refrigerant clogs filters inside the piping and is basically the same phenomenon as pump down.

*** Pressure differential between high and low pressure becomes low.

3. Clean the indoor heat exchanger (if necessary. Example: contaminated by cooking oil, ...).

- Use proper field supply cleaning agent which is suitable for cleaning heat exchangers and drain pans.
- Clearly follow the instructions of local supply cleaning agent and do not use household cleaning agents.
- Please rinse the heat exchanger and drain pan with water after the cleaning process. (*)



CAUTION

* Rinse out the cleaning agent until there is no cleaning agent left. Otherwise, the corrosion of heat exchanger and drain pan may occur.

Pay attention to the cleaning agent that may also corrode other materials of indoor unit (Aluminium, copper, plastic, ABS, ...).

4.2. Outdoor unit

4.2.1. General maintenance outdoor unit

1. Outdoor unit coil

- Straighten hair fins.
- Clear coil from dust, leaves, etc. with a fin-comb, or compressed air/N₂. Avoid bending or damaging of the Alu fins during the cleaning process.
- Remove the icicles during winter season. Use gloves to avoid injury and unit damage.

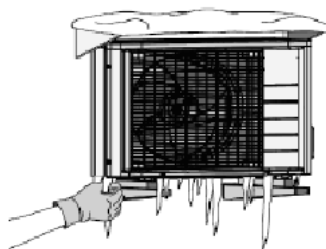

CAUTION

Make sure not to bend the hair fins.

2. Correlation of air-conditioner's operation status, pressure and running current.

COOLING	Low pressure	High pressure	Running current
Dirty air filter	Higher	Higher	Higher
Short circuit of air inlet/outlet	Higher	Higher	Higher
Air mixed in refrigerant	Higher	Higher	Higher
Water mixed in refrigerant	Lower*	Lower	Lower
Dirt mixed in refrigerant	Lower**	Lower	Lower
Refrigerant shortage (gas)	Lower***	Lower	Lower

* Water in the refrigerant freezes inside the electronic expansion valve and is basically the same phenomenon as pump down.

** Dirt in the refrigerant clogs filters inside the piping and is basically the same phenomenon as pump down.

*** Pressure differential between high and low pressure becomes low.

1.

Part 5. Appendix

This part contains the following chapters:

Field setting	107
Detailed information setting mode	115
Wiring diagram	123
Piping diagram	128
Component overview of unit	129
Product specific information	132
Switch box	133
Field information report	133

5.1. Field setting

5.1.1. Indoor unit

5.1.1.1. Retrieve field settings BRC1E

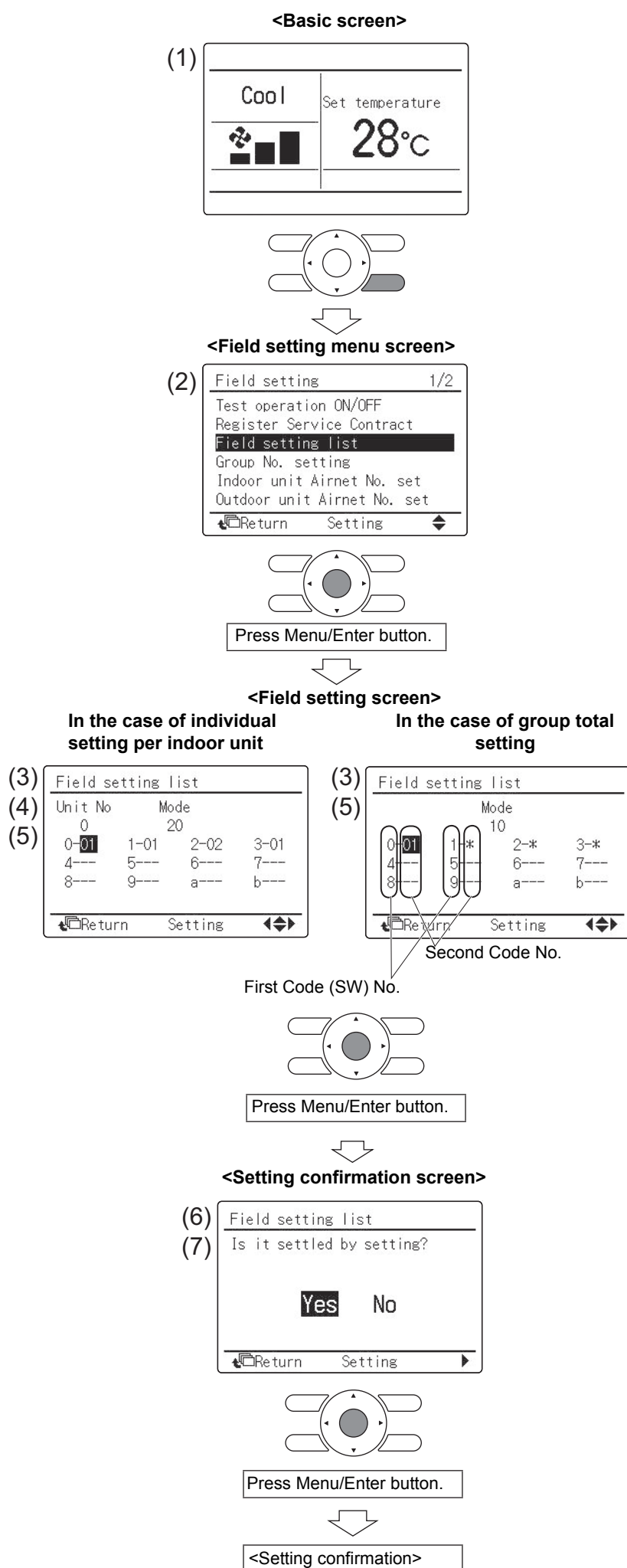

1. Press and hold Cancel button for 4 seconds or more. Field setting menu is displayed.
2. Select *Field setting list* in the field setting menu, and press Menu/Enter button.
Field setting list screen is displayed.
3. Highlight the mode, and select desired "Mode No." by using ▲▼ (Up/Down) button.
4. In the case of setting per indoor unit during group control (When Mode No. such as 20, 21, 22, 23, 25 are selected), highlight the unit No. and select "Indoor unit No." to be set by using ▲▼ (Up/Down) button. (In the case of group total setting, this operation is not needed.)
In the case of individual setting per indoor unit, current settings are displayed. And, Second Code No. "-" means no function.
5. Highlight Second Code No. of the First Code No. to be changed, and select desired "Second Code No." by using ▲▼ (Up/Down) button. Multiple identical mode number settings are available.
In the case of group total setting, all of Second Code No. which may be set are displayed as "**".
"**" is changed to Second Code No. to be set. And, Second Code No. "-" means no function.

6. Press Menu/Enter button. Setting confirmation screen is displayed.
7. Select Yes and press Menu/Enter button. Setting details are determined and field setting list screen returns.
8. In the case of multiple setting changes, repeat “(3)” to “(7)”.
9. After all setting changes are completed, press Cancel button twice.
10. Backlight goes out, and “Connection under check Please wait for a moment” is displayed for initialization. After the initialization, the basic screen returns.

**CAUTION**

- When an optional accessory is installed on the indoor unit, settings of the indoor unit may be changed. See the manual of the optional accessory.
- For field setting details of the outdoor unit, see installation manual attached to the outdoor unit.

5.1.1.2. Retrieve field settings BRC7

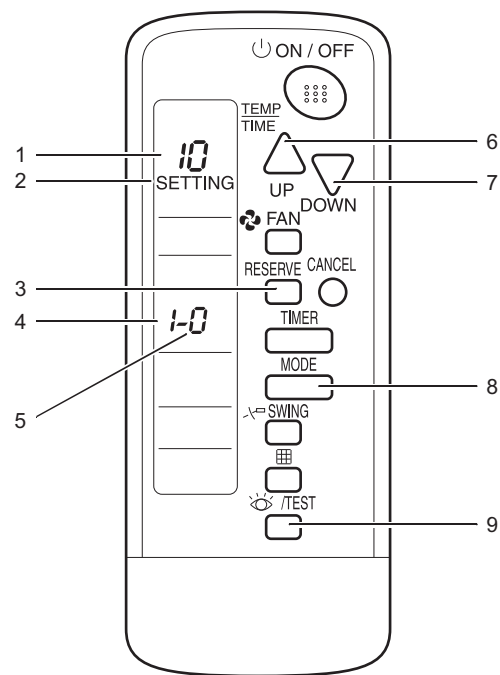

- | | | |
|-----------------------|--------------------|---------------------------|
| 1. Mode No. | 4. First code No. | 7. DOWN button |
| 2. Field setting mode | 5. Second code No. | 8. MODE button |
| 3. RESERVE button | 6. UP button | 9. INSPECTION/TEST button |

Setting

To set the field settings, you have to change:

- “Mode No.”
- “First code No.”
- “Second code No.”.

To change the field settings, proceed as follows:

1. Hold down the INSPECTION/TEST button for at least 4 s during normal mode to enter the “Field setting mode”.
2. Press the MODE button to select the desired “Mode No.”.
3. Press the UP button to select the “First code No.”.
4. Press the DOWN button to select the “Second code No.”.
5. Press the RESERVE button to set the present settings.
6. Press the INSPECTION/TEST button to return to the “Normal mode”.

5.1.1.3. Retrieve field settings BRC1H

5.1.1.3.1 BRC1H remote controller

See the installer and user reference guide of the Madoka wired remote controller for correct procedure.

5.1.1.3.2 Madoka Assistant for BRC1H

Set as installer mode

In order to retrieve the field settings, the Madoka Assistance app has to be set as installer mode. If already set as installer mode, skip to Retrieve field settings.

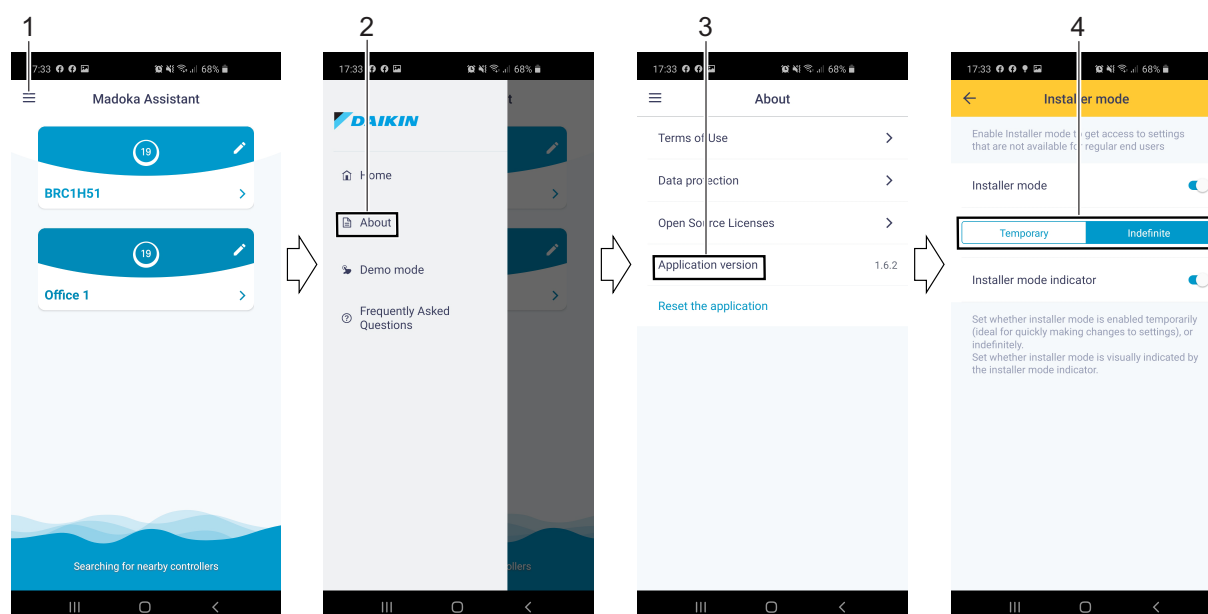

1. Tap the menu icon.
2. Tap "About".
3. Tap "Application version" 5 times. Installer mode screen is displayed.
4. Select (tap) the length of time the Madoka Assistance app is set as installer mode: "Temporary" for 30 minutes and "Indefinite" for unlimited time.

Retrieve field settings

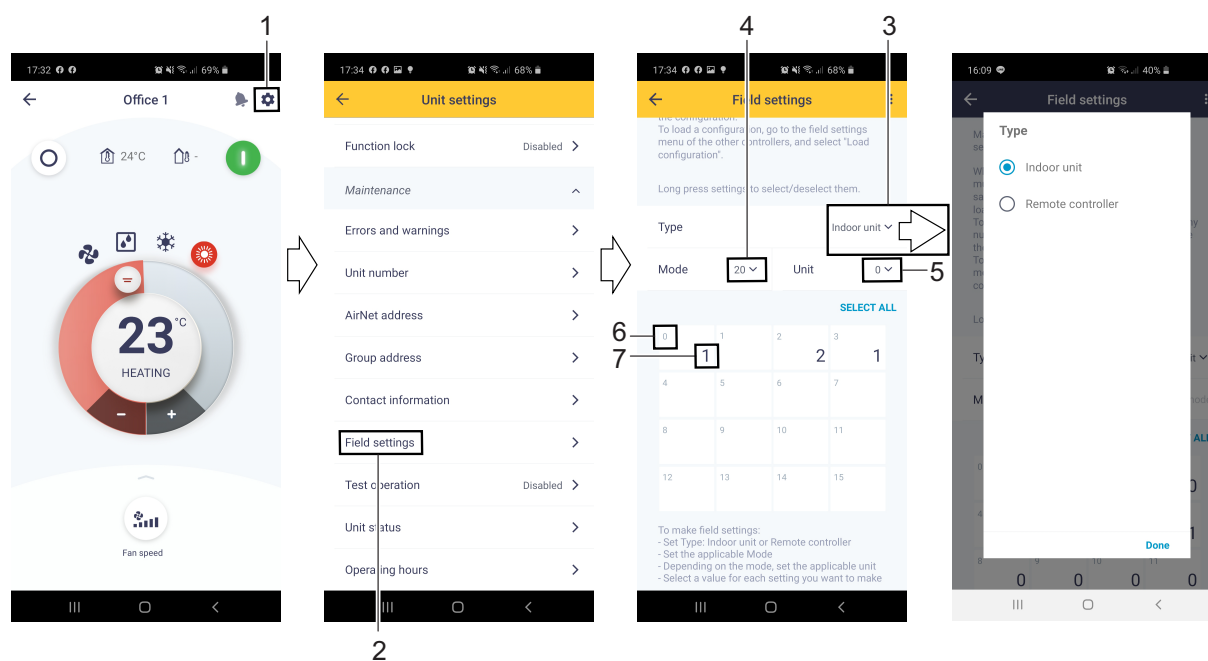

1. Tap the settings icon. The "Unit settings" screen appears.
2. Tap "Field settings". The "Field settings" screen appears.
3. Tap and select the type ("Indoor unit" or "Remote controller") for which you want to set the field settings.
4. Tap and select the desired "Mode No" from the drop down list.
5. In the case of setting per indoor unit during group control (when Mode No. such as 20, 21, 22, 23, 25 are selected), tap and select the "Indoor unit No." which is required to be set. (In the case of group total setting, this operation is not needed.)
In the case of individual setting per indoor unit, current settings are displayed. And, Second Code No. "-" means no function.
6. Tap the Second Code No. of the First Code No. to be changed.
7. Select desired "Second Code No.". Multiple identical mode number settings are available.
In the case of group total setting, all of Second Code No. which may be set are displayed as "**".
"**" is changed to Second Code No. to be set. And, Second Code No. "-" means no function.



INFORMATION

In case of multiple setting changes, repeat steps 4 through 7.

Retrieve field settings

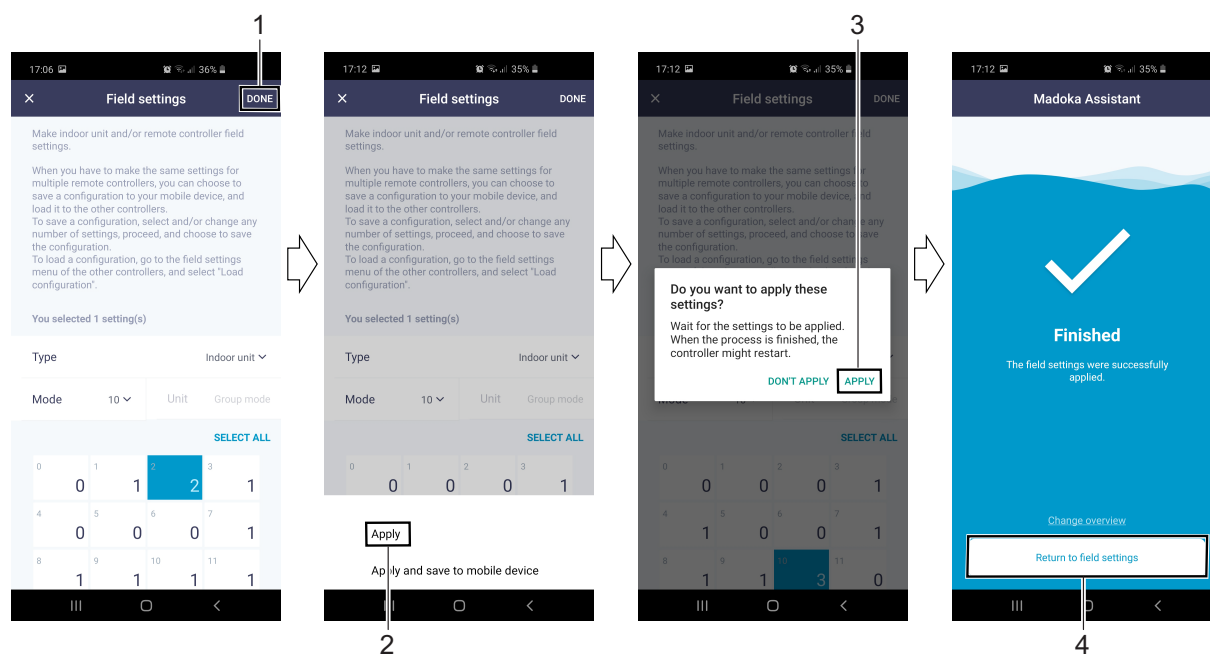

1. After finishing the setting(s), tap the "DONE" icon.
2. Tap "Apply" to apply the set field settings.
3. Tap "Apply" to confirm.
4. Tap "Return to field settings" to end the settings.

5.1.1.4. Sky-Air R32 indoor field settings

Mode No.	First Code No.	Description of Setting	Second Code No.					
			01	02	03	04	05	
10 (20)	0	Filter cleaning sign interval	Long life filter	2,500 hrs. (factory setting)	—	—	—	—
	1	Filter type		Super long	—	—	—	—
	2	Remote controller thermostat		Enabled	—	—	—	—
	3	Filter cleaning sign		Display (factory setting)	—	—	—	—
	7 (note 3)	Detection time for NOT presence		30 min (factory setting)	—	—	0,,,0	—
	8 (note 4)	Compensation of suction air temperature in heating mode		COMPENSATE (Temperature [A+2] °C which an air conditioner controls when the temperature of a remote controller is A °C) (factory setting)	—	—	—	—
11 (21)	2	Fan OFF at Thermostat OFF		Normal (factory setting)	—	—	—	—
	3	Airflow rate setting during heating		Standard (factory setting)	—	Up	—	—
	4	Automatic operation mode control		Available (factory setting)	—	—	—	—
	6 (note 5)	Sensitivity of presence sensor		High	—	Standard (factory setting)	—	Sensor does not work
11 (22)	0	Option (KRP1B*) output		Compressor (factory setting)	—	Operation	—	Malfunction
	7 (note 5)	Compensation of temperature around human body		Floor sensor does not work	—	Standard (factory setting)	—	Higher priority on the floor temperature
	8 (note 5)	Compensation of floor temperature		-4°C	—	±0°C (factory setting)	—	+2°C
12 (22)	3	Fan speed heating thermostat OFF		LL-speed (factory setting)	—	—	—	—
	5	Automatic restart after power failure reset		Disabled	—	—	—	—
	6	Fan speed cooling thermostat OFF		LL-speed	—	—	—	—
13 (23)	0	High air outlet velocity (for high ceiling applications)		Standard (factory setting)	—	Up	—	—
	1	Selection of airflow direction		4-way flow (factory setting)	—	—	—	—
	2	Flap moving in the swing mode		All 4 flaps synchronized	—	Two opposite flaps synchronized (factory setting)	—	—
	4	Airflow range setting		Upper	—	Lower	—	—
14 (24)	2	The largest time interval for Dust Collection Sign Display for "self cleaning decoration panel"		About 1250 hrs (dusty place)	—	About 5000 hrs (less dusty place)	—	—
	4	Display or non-display of green lamp on the selfcleaning decoration panel		Display both: - airconditioning operation, - filter auto cleaning	—	Display: - airconditioning operation, Non display: - filter auto cleaning	—	—
	8	Auto control operation for Filter Auto Cleaning		Auto control operation	—	Not auto control operation (factory setting)	—	—
	9	Filter cleaning time for "selfcleaning decoration panel"		Normal place in terms of dust (Normal office) (factory setting)	—	In case of dusty place	—	—
15 (25)	5	Individual setting of ventilation		Normal (factory setting)	—	Individual operation	—	—
1b (2b)	14	Wind block (note 6) enable / disable setting		Enable (factory setting)	—	—	—	Disable



INFORMATION

- Settings are made simultaneously for the entire group, however, if you select the mode No. inside parentheses, you can also set by each individual unit. Setting changes however cannot be checked except in the individual mode for those in parentheses. (Even if the setting are made for the entire group, the display always indicates "01".)
- "88" may be displayed to indicate the remote controller is resetting when returning to the normal mode.
- This function does not work when "SET BACK Function" is set by remote controller.
- This is the case when the remote sensor (optional kit) is used.
- This is the case when the sensor option (optional kit) is used.
- Wind block: one of 4 flaps can be set a block position (block position = closed position). Wind can not be blocked 100% but mostly blocked without additional parts.

5.1.2. Outdoor unit

5.1.2.1. Retrieve field settings OU mode 1 / mode 2

5.1.2.1.1 Location of the 7 segment display and BS Buttons

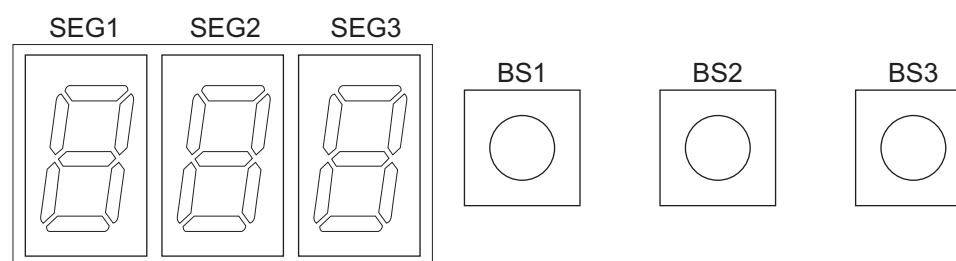

Meaning of the BS buttons:

- BS1:Mode
- BS2:Set
- BS3:Confirm/Back

Two outdoor field setting modes are available by using the BS1 buttons on the PCB.

- Mode 1: used to read out information of the outdoor PCB.
- Mode 2: used to set outdoor unit settings.

5.1.2.1.2 Field Setting for Outdoor Unit

Mode 1

- This mode is used to read out information of the outdoor PCB.
- Press the BS1 button once to activate Mode 1.
- In this mode, the following information can be retrieved via the 7 segment display.

No.	Setting item
0	Indication of low noise
1	Indication of demand operation
2	Indication of oil return
3	Indication of capacity class
4	Last error code (*)
5	2nd last error code
6	3rd last error code
7	Software number
8	Software version (e.g.: version 01/02/...)
9	Compressor stepping down protection
10	Result of Service function to check lack of refrigerant
11	Outdoor unit cumulative operating time (Unit: Hours/100)
12	Compressor cumulative operating time (Unit: Hours/100)
13	Inverter secondary current

No.	Setting item
14	Outdoor fan speed step
15	Inverter output Hz
16	Expansion valve opening 1
17	Expansion valve opening 2
18	Outdoor unit compressor discharge sensor temperature
19	Outdoor unit suction pipe sensor temperature
20	Outdoor unit air sensor temperature
21	Outdoor unit liquid pipe sensor temperature
22	Outdoor unit middle coil sensor temperature
23	Outdoor unit coil sensor temperature
24	Indoor unit air return temperature
25	Indoor unit liquid pipe temperature
26	Indoor unit gas pipe temperature

(*) How to read out the last error code:

1. Press the BS1 button once.
2. Press the BS2 button 5 times to select the latest error
3. Press the BS3 button once to confirm the selection.

Mode 2

- This mode is used to set outdoor unit settings.
- In this mode, settings for the following items can be made.
- Press and hold the BS1 button for 5 seconds to activate Mode 2.

	<p>INFORMATION</p> <p>For more information about the outdoor unit settings in Mode 2, refer to "Outdoor unit" on page 115.</p>
---	---

5.1.3. Remote controller

Mode No.	First Code No.	Description	Second Code No.					Details
			01	02	03	04	05	
16 (26)	0	Night time low noise operation	Disabled (Factory setting)	Automatic low noise activation	Capacity preceding setting (when using KRP58 option)	Automatic low noise + capacity preceding	—	Refer to "Quiet (Low Noise) Operation" on page 117.
	1	Automatic low noise start and stop time	—	—	22h00 ~ 06h00	22h00 ~ 08h00 (Factory)	20h00 ~ 08h00	Refer to "Quiet (Low Noise) Operation" on page 117.
	2	EDP room setting	Disabled (Factory setting)	—	EDP room setting	EDP room setting + no freeze up	—	Refer to "Setting for Low Humidity Application" on page 119.
	3	Defrost starting setting	Standard (Factory setting)	Defrost slow starting setting	Defrost quick starting setting	—	—	Refer to "Defrost Operation" on page 121.
	7	Slow start for EDP applications	Normal start	Slow start	—	—	—	

5.2. Detailed information setting mode

5.2.1. Indoor unit

Not applicable.

5.2.2. Outdoor unit

How to Access & Set the Outdoor Unit Settings (Mode 2)



1. Press and hold the BS1 button for 5 seconds to activate the outdoor unit settings (accessing Mode 2).
2. Press the BS2 button (set) for the required setting.
3. Press the BS3 button (return) once to confirm the setting.
4. Press the BS2 button to set the setting condition.
5. Press the BS3 button once to confirm the setting.
6. Press the BS3 button once to exit the setting.

Outdoor Unit Settings (Mode 2)

No.	Setting item	7 segment display			Setting Condition	7 segment display		
		SEG1	SEG2	SEG3		SEG1	SEG2	SEG3
2	Power transistor check mode settings	2	0	2	OFF (factory set)			0
					ON			1
3	Demand 2 setting out	2	0	3	50%			1
					40% (factory set)			2
					30%			3
11	TeS lower limit settings	2	1	1	L:0°C			1
					M:2°C			2
					H:4°C (factory set)			3
					HH:6°C			4
28	Refrigerant recovery mode settings	2	2	8	OFF (factory set)			0
					ON			1
33	TeS lower settings 2	2	3	3	0 (factory set)			1
					6			2
					9			3
					11			4
					13			5
					16			6
					17			7
					TeS lower limit depending on outside temperature			8
34	TcS upper setting	2	3	4	60 (factory set)			1
					50			2
					47			3
					45			4
					43			5
					TcS upper limit depending on outside temperature			6
55	Drain pan heater ON time after the end of defrosting	2	5	5	1 min (factory set)			1
					5 min			2
					10 min			3
					15 min			4
					25 min			5
					30 min			6
					45 min			7
56	Coefficient A (TeS lower limit depending on outdoor air temperature)	2	5	6	9 (factory set)			1
					11			2
					13			3
					15			4
57	Coefficient B (TeS lower limit depending on outdoor air temperature)	2	5	7	2 (factory set)			1
					4			2
					6			3
					8			4
58	Coefficient C (TeS lower limit depending on outdoor air temperature)	2	5	8	14 (factory set)			1
					17			2
					20			3
					23			4

No.	Setting item	7 segment display			Setting Condition	7 segment display		
		SEG1	SEG2	SEG3		SEG1	SEG2	SEG3
59	Coefficient D (TeS lower limit depending on outdoor air temperature)	2	5	9	23 (factory set)			1
					27			2
					31			3
					35			4
60	Coefficient E (TcS lower limit depending on outdoor air temperature)	2	6	0	47 (factory set)			1
					48			2
					49			3
					50			4
61	Coefficient F (TcS lower limit depending on outdoor air temperature)	2	6	1	43 (factory set)			1
					44			2
					45			3
					46			4
62	Coefficient G (TcS lower limit depending on outdoor air temperature)	2	6	2	2 (factory set)			1
					5			2
					8			3
					11			4
63	Coefficient H (TcS lower limit depending on outdoor air temperature)	2	6	3	15 (factory set)			1
					18			2
					21			3
					24			4

5.2.3. Remote controller

5.2.3.1. Quiet (Low Noise) Operation

Lower the operation sound of the outdoor unit.

Silent Operation can be activated by:

1. Automatic control (by field setting from remote controller)
2. External activation (from optional PCB KRP58M)

Quiet (Low Noise) Operation by Automatic Control

Silent operation can be set by field setting from the wired remote controller:

Description	Mode No.	First Code No.	Second Code No.				
			01	02	03	04	05
Silent Operation	16(26)	0	OFF	Low noise activation	—	Low noise + capacity priority	—
Low noise start & stop time		1	—	—	22h00 ~ 06h00	22h00 ~ 08h00	20h00 ~ 08h00

When setting mode 16(26)-0-02, quiet (low noise) operation will be carried out by presuming the current time in accordance with the outside temperature.

Automatic mode will start when the outdoor temperature is = average max of last 10 days -5°C and will be conducted for 10 hours.

The maximum outdoor temperature is supposed to occur at 14:00h.

As the time judgement is made in accordance with the outdoor temperature, the above mentioned timing is an estimation only.

When setting mode 16(26)-0-04, the low noise operation will be stopped when the heating or cooling load increases. In that case, the operation will return to normal operation. The unit will return to low-noise operation when the heating or cooling load decreases again.

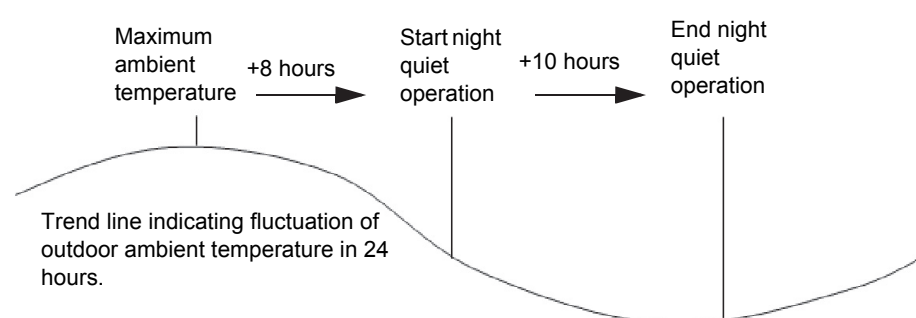

External Activation from Optional PCB

Quiet (low noise) operation can also be activated from the optional PCB.

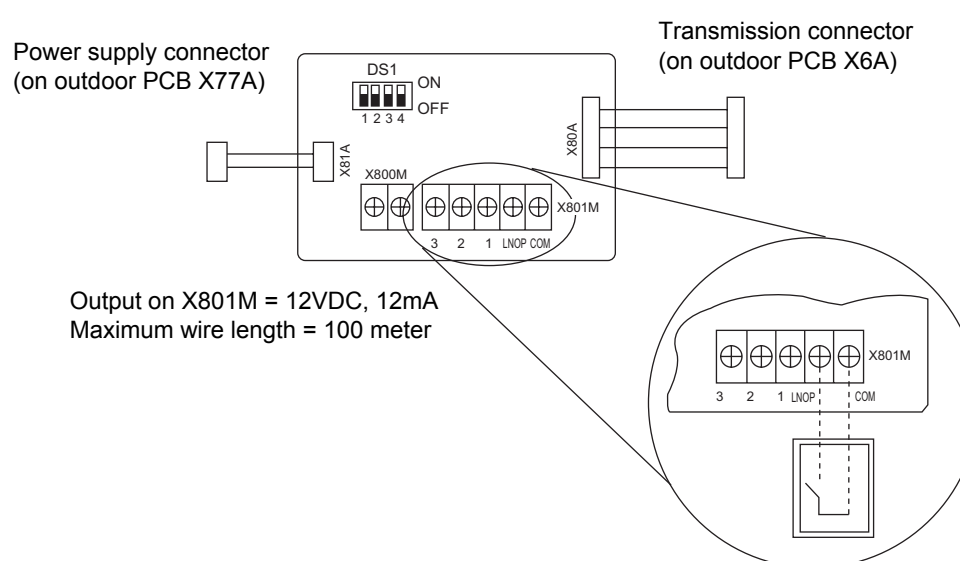

Quiet (low noise) operation will start when the contact on LNOP-COM is closed and will remain active as long as the contact is closed. No field setting on the outdoor unit or by remote controller is required.

Quiet (low noise) operation will be ended when the contact is re-opened.

Use of the KRP58M enables the use of an external time clock.

Same as with the automatic control, priority for capacity can be set. Priority for capacity will be activated by changing field setting 26-0-03 in combination with the closed contact on KRP58M.

Description	Mode No.	First Code No.	Second Code No.			
			01	02	03	04
Quiet (low noise) operation	16(26)	0	Factory setting	—	Capacity priority setting	—

The Quiet (low noise) operation will be overruled in the following conditions:

- Pump down residual operation
- Startup control
- Defrost operation
- Oil recovery

Model	RZAG71M	RZAG100M	RZAG125M	RZAG140M
Sound reduction	4 dBA	3 dBA	6 dBA	7 dBA



INFORMATION

Sound reduction was measured on the condition of Level 3 low noise setting in cooling mode.

5.2.3.2. I-Demand Function

Set a limitation towards the power consumption from the system (e.g. budget control, limit power consumption during peak moments, ...).

3 different demand setting can be selected by using terminal X801M:

- Demand 1 → Close contact between COM and contact 1
- Demand 2 → Close contact between COM and contact 2
- Demand 3 → Close contact between COM and contact 3

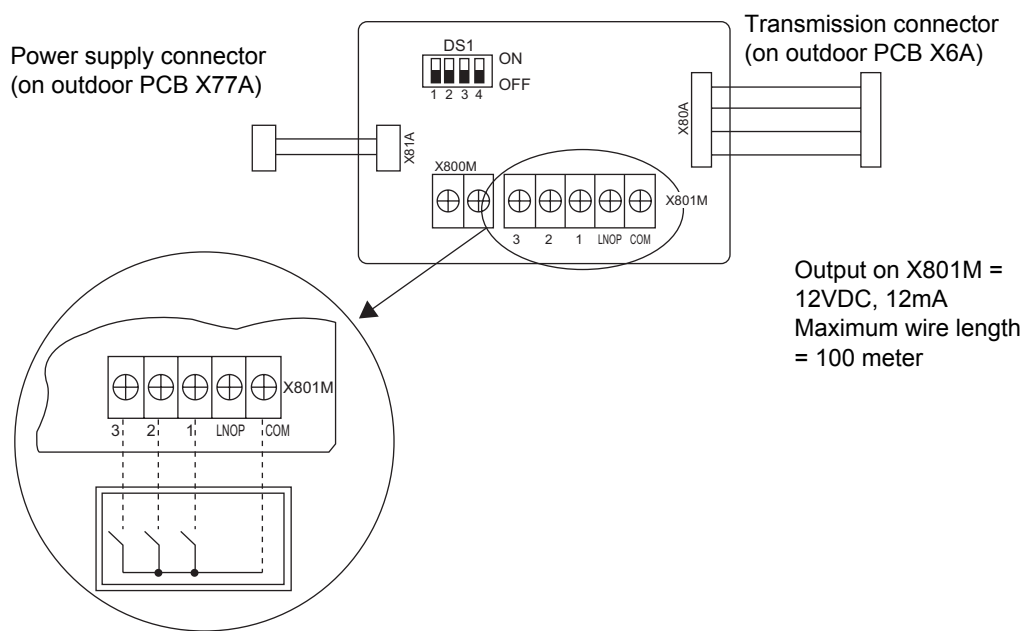

Demand 1

Power consumption limitation in function of setting on DS1.

DS1 Setting		ON OFF 1 2 3 4	Maximum Power Consumption
1	2		
OFF	OFF	ON OFF 1 2 3 4	60%
ON	OFF	ON OFF 1 2 3 4	70%
OFF	ON	ON OFF 1 2 3 4	80%
ON	ON	ON OFF 1 2 3 4	100%

Demand 2

Power consumption limitation set to 40%.

Demand 3

Forced thermostat OFF.

5.2.3.3. Setting for Low Humidity Application

Can be set when using the RZAG-M units for year round cooling in low humidity applications such as computer rooms (EDP rooms), technical rooms, etc...to increase the capacity of the unit.

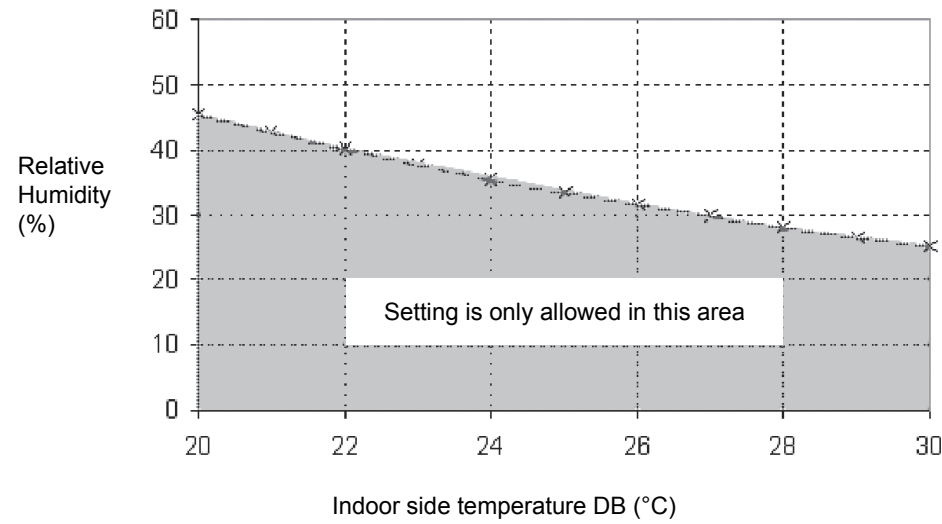

CAUTION
When using the "LH settings" outside the "Low Humidity Area" there is an increased risk of ice accumulation on the indoor coil or water blowing out from the indoor unit.

		Factory setting	Low humidity application setting	Low humidity application + freeze up operation prevention
Field Setting		16(26)-2-01	16(26)-2-03	16(26)-2-04
Compressor control		<ul style="list-style-type: none"> The compressor frequency is controlled in function of the target evaporating temperature. The target evaporating temperature is controlled in function of the cooling load. 		
		Minimum target Te = 2°C	Minimum target Te = 0°C	Initial minimum target Te = 2°C, but can be changed in function of actual Te, to avoid freeze up activation: <ul style="list-style-type: none"> Te ≤ -1°C for 20 minutes accumulated => Change target Te ≥ 5°C Te ≤ -1°C for 30 minutes accumulated => Change target Te ≥ 8°C
		See graph 1	See graph 2	See graph 3
Freeze protection function	Start	Te ≤ -1°C for 40 minutes accumulated OR Te ≤ -3°C for 1 minute continuous (Indoor decision)	Te ≤ -1°C for 40 minutes accumulated OR Te ≤ -3°C for 1 minute continuous (Outdoor decision)	Te ≤ -1°C for 40 minutes accumulated OR Te ≤ -3°C for 1 minute continuous (Outdoor decision)
	End	Te > 7°C for 10 minutes continuously. (Indoor decision)	Te > 7°C for 3 minutes continuously OR Te > 4°C for 20 minutes continuously (Outdoor decision)	Te > 7°C for 3 minutes continuously OR Te > 4°C for 20 minutes continuously (Outdoor decision)

Graph 1

Target evaporating temperature control in case of factory setting 16(26)-2-01:

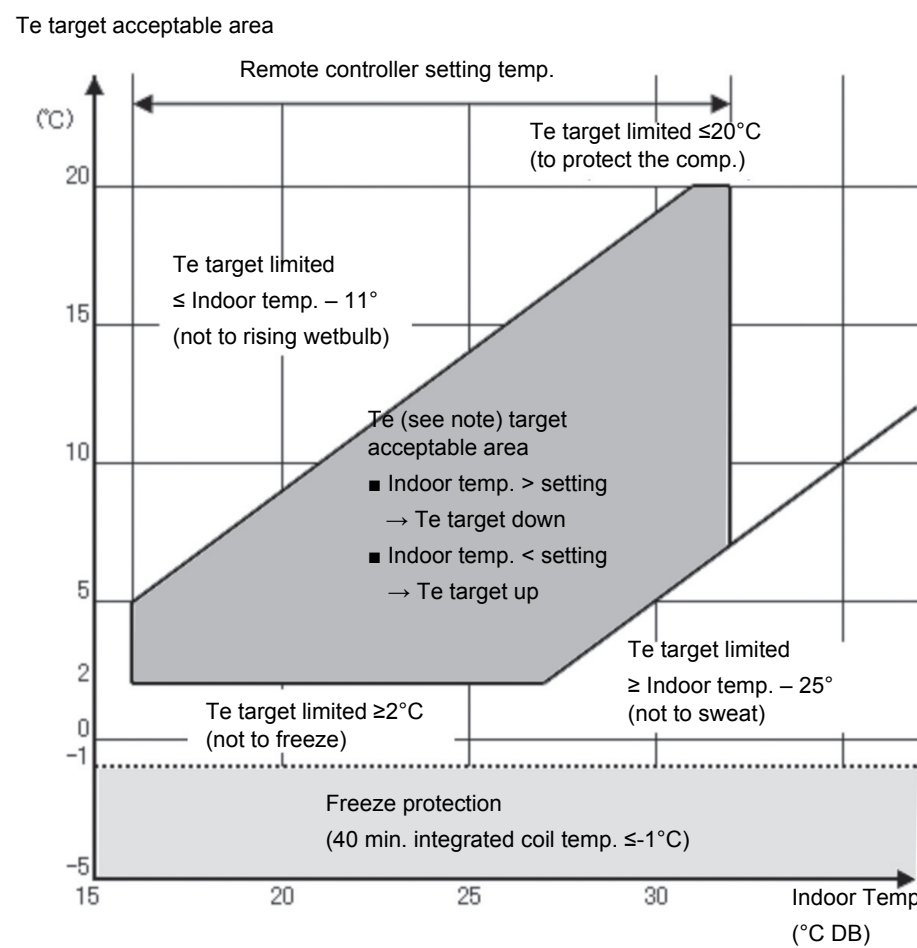

Graph 2

Target evaporating temperature control when "low humidity application" is selected. Field setting 16(26)-2-03:

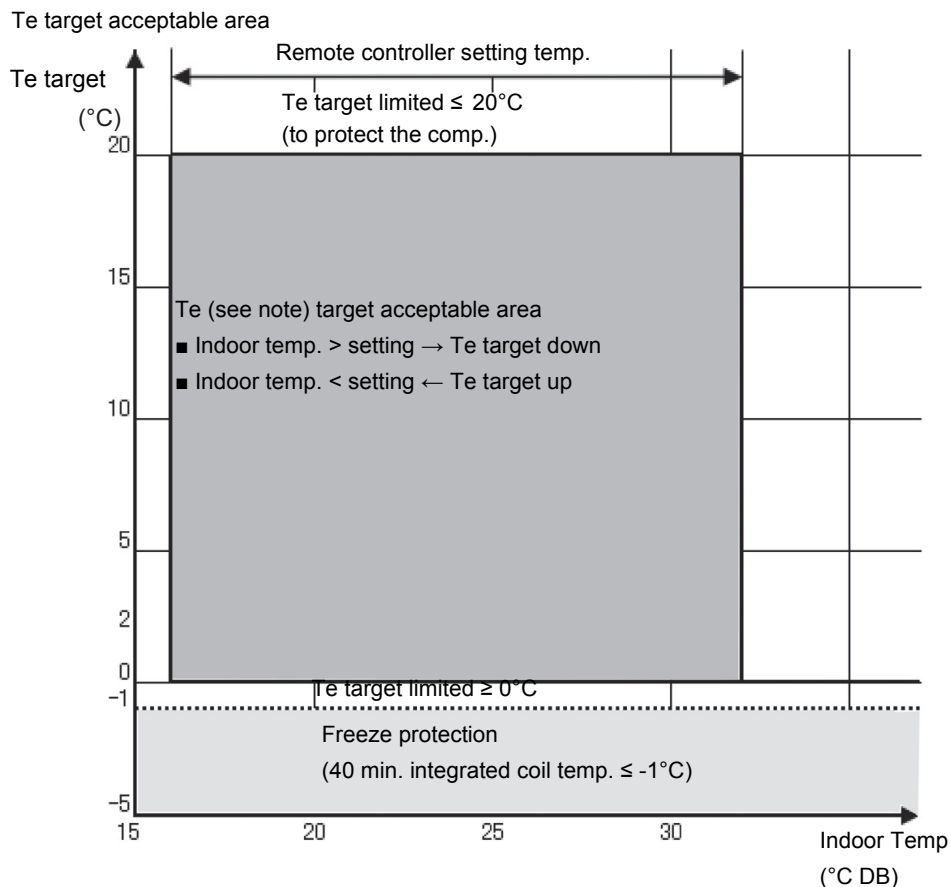

Graph 3

Target evaporating temperature control when "low humidity application + freeze up operation prevention" is selected. Field setting 16(26)-2-04:

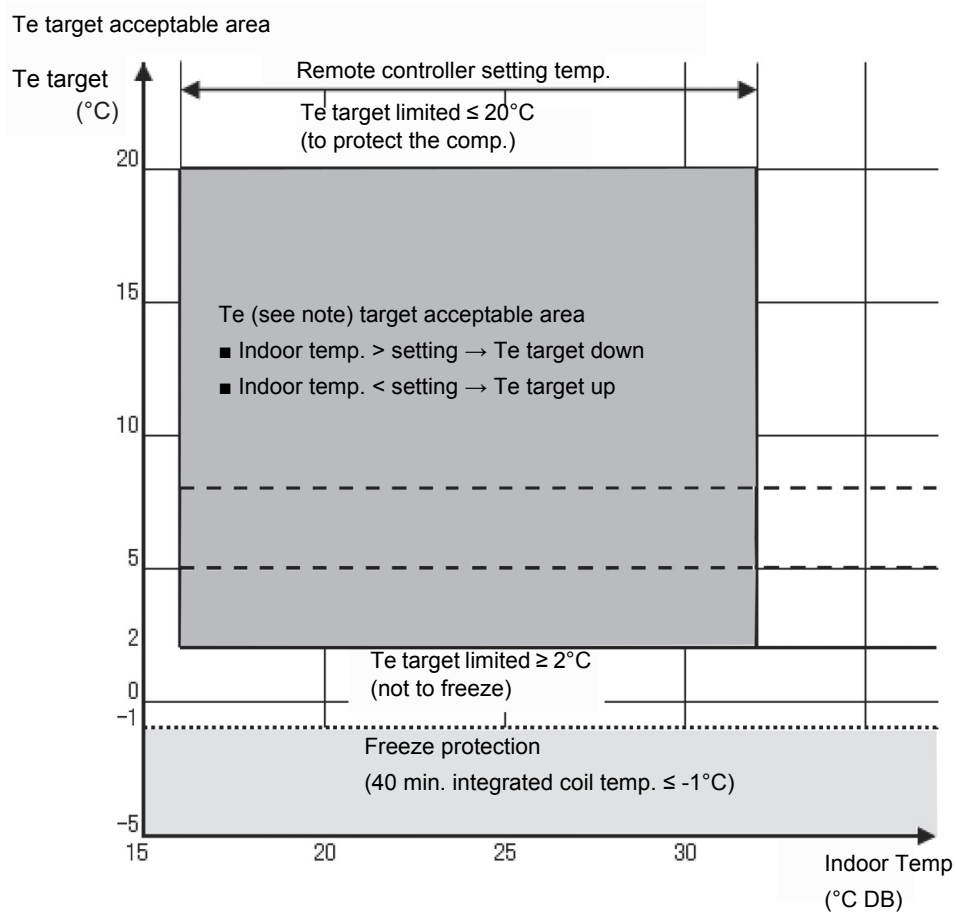

In order to increase continuous operation of the unit in low latent heat applications and avoid the rise of temperature after thermostat OFF, the thermostat control will be changed when using field settings 16(26)-2-03 & 16(26)-2-04.

Thermostat ON

- $\Delta Trs \geq 0.5^\circ\text{C}$ (No change from standard setting)

Thermostat OFF

- $\Delta Trs \leq -2.0^\circ\text{C}$ for 5 minutes continuously.
- $\Delta Trs \leq 4.5^\circ\text{C}$

Capacity

When "low humidity application" is selected. Field setting 16(26)-2-03:

Outdoor Temp. (°C-DB)	Indoor Temp. (°C-WB)							
	11	14	16	18	19	20	22	24
	Capacity (% of standard point)							
-15	0.62	0.76	0.86	0.95	1.00	1.02	1.07	1.11
-10	0.62	0.76	0.86	0.95	1.00	1.02	1.07	1.11
-5	0.62	0.81	0.91	1.01	1.06	1.16	1.21	1.26
0	0.62	0.81	0.91	1.01	1.06	1.16	1.21	1.26

Outdoor Temp. (°C-DB)	Indoor Temp. (°C-WB)							
	11	14	16	18	19	20	22	24
	Capacity (% of standard point)							
5	0.62	0.81	0.91	1.01	1.06	1.16	1.21	1.26
10	0.62	0.81	0.91	1.01	1.06	1.16	1.21	1.26
15	0.62	0.81	0.91	1.01	1.12	1.14	1.19	1.24
20	0.62	0.81	0.91	1.07	1.10	1.12	1.16	1.21
25	0.62	0.81	0.91	1.05	1.07	1.09	1.13	1.18
30	0.61	0.81	0.91	1.01	1.04	1.06	1.10	1.14
35	0.61	0.81	0.94	0.98	1.00	1.02	1.06	1.11
40	0.61	0.81	0.90	0.94	0.96	0.98	1.02	1.06

When "low humidity application + freeze up operation prevention" is selected. Field setting 16(26)-2-04:

Outdoor Temp. (°C-DB)	Indoor Temp. (°C-WB)							
	11	14	16	18	19	20	22	24
	Capacity (% of standard point)							
-15	0.51	0.68	0.78	0.95	1.01	1.06	1.16	1.26
-10	0.51	0.68	0.78	0.95	1.01	1.06	1.16	1.26
-5	0.51	0.68	0.78	0.95	1.01	1.06	1.16	1.26
0	0.51	0.68	0.78	0.95	1.01	1.06	1.16	1.26
5	0.51	0.68	0.78	0.95	1.01	1.06	1.16	1.26
10	0.51	0.68	0.78	0.95	1.01	1.06	1.16	1.26
15	0.51	0.68	0.78	0.95	1.01	1.06	1.16	1.24
20	0.51	0.68	0.78	0.95	1.01	1.06	1.16	1.21
25	0.51	0.68	0.78	0.95	1.00	1.06	1.13	1.18
30	0.51	0.68	0.78	0.95	1.00	1.05	1.10	1.14
35	0.51	0.68	0.78	0.95	1.00	1.02	1.06	1.11
40	0.51	0.67	0.78	0.94	0.96	0.98	1.02	1.06



INFORMATION

- Operation range on indoor side expanded from minimum 12°CWB to 11°CWB when using LH setting.
- Do not use a setpoint below 20°C to avoid operation out of the indoor operation range (11°CWB).
- Be sure to set the indoor fan to high speed.

5.2.3.4. Defrost Operation

When in heating mode, a defrost operation will be conducted in order to avoid ice formation on the outdoor unit heat exchanger.

Starting conditions

Defrost will start when the following conditions have been realized:

- & [• Integrated compressor running time is 25 minutes or more since the completion of the previous defrost operation.
 OR [• Defrost upper limit time A is met.
 • Outdoor unit heat exchanger temperature is within the defrost request area.

Defrost conditions

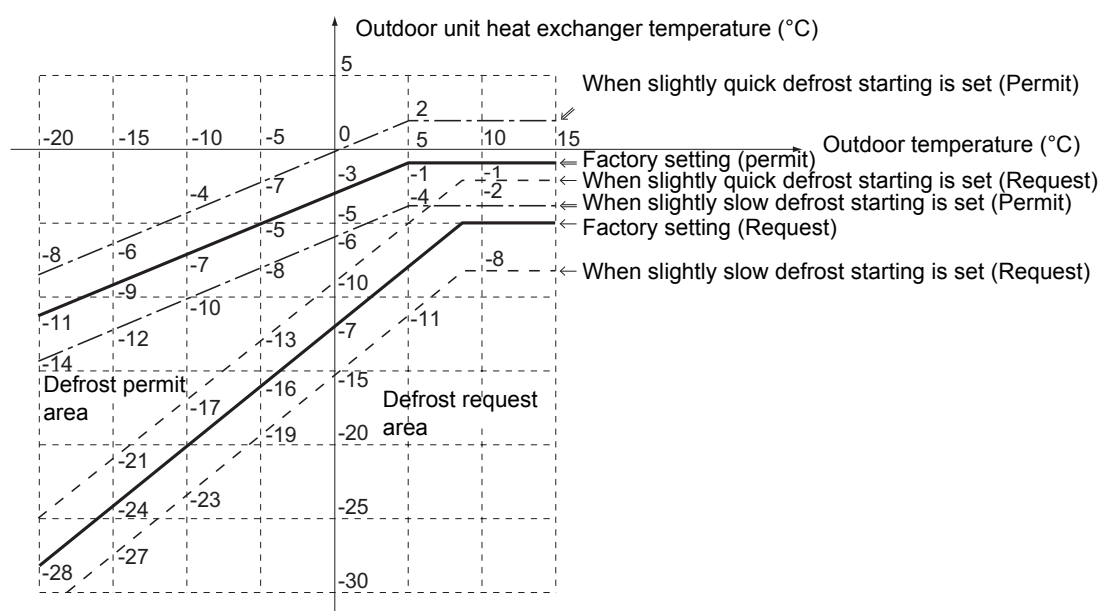

Defrost upper limit A

Depending on the defrost start setting (field setting mode of the indoor unit remote controller), frost upper limit time A becomes as shown in the table below.

	When quick defrost starting is set	Factory setting	When slow defrost starting is set
Outdoor air temperature > -5°C	40 minutes	2 hours	6 hours
Outdoor air temperature ≤ -5°C	40 minutes	6 hours	8 hours

Defrost Control

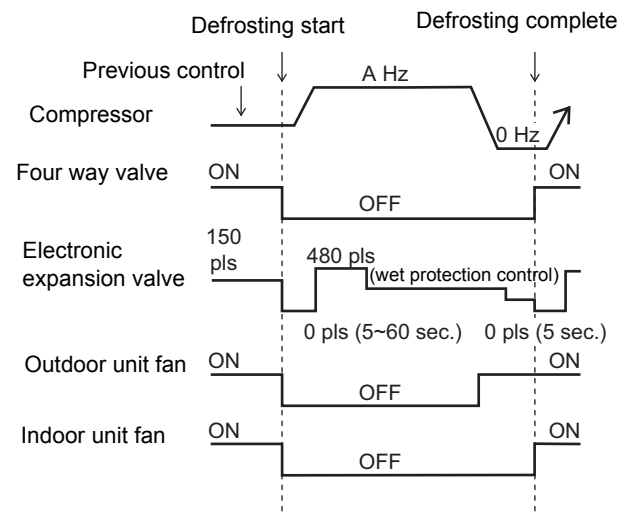

Defrost Ending Conditions

Defrosting ends when the following conditions have been realized. Note that defrosting can be operated for 10 minutes at longest.

Hp: High pressure

Tb: Heat exchanger distributor pipe temperature

Tm: Intermediate heat exchanger temperature

- OR (
 - & (
 - Defrost Time > 10 sec.
 - Hp > 2.45 MPa
 - & (
 - Defrost Time > 1 min.
 - Tb > 10°C
 - Tm > 12°C
 - & (
 - Defrost Time > 9 min.
 - Tb > 8°C
 - Tm > 10°C

5.3. Wiring diagram

5.3.1. Indoor unit

Figure 5-1: Wiring diagram - indoor unit

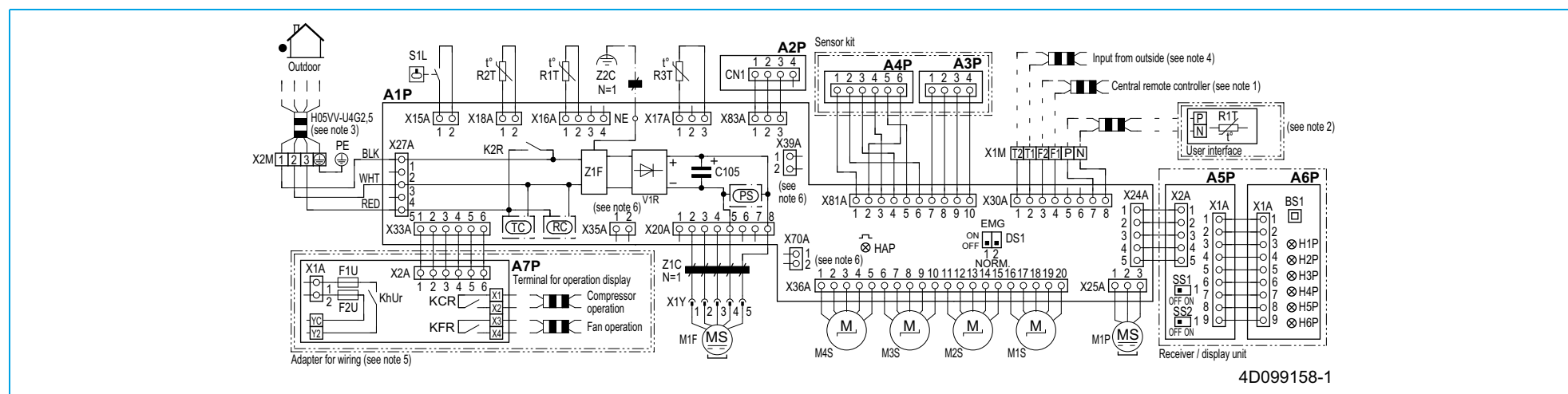

Notes

1. In case using central remote controller, connect it to the unit in accordance with the attached installation manual.
2. In case of main/sub changeover. See the installation manual attached to remote controller.
3. Shows only in case of protected pipes. Use H07RN in case of no protection.
4. When connecting the input wires from outside, forced off or on/off control operation can be selected by the remote controller. See installation manual for more details.
5. Connect power of adapter for wiring to terminal block (X2M) of indoor unit directly.
6. X35A, X39A, X70A are connected when the optional accessories are being used. In case an auto cleaning panel is used, see the wiring diagram.

Legend

A1P	Main PCB	V1R (A1P)	Diode module
A2P	Adapter PCB	X1A (A7P)	Connector (power supply for option PCB)
A3P, A4P	* Sensor kit PCB	X2A (A7P)	PCB connector (sensor kit)
A5P, A6P	Receiver/display PCB	X24A (A1P)	PCB connector (wireless remote controller)
A7P	* Adapter for wiring	X33A (A1P)	PCB connector (adapter for wiring)
BS01 (A6P)	Push button (ON/Off)	X35A (A1P)	PCB connector (auto clean panel)
C105 (A1P)	Capacitor	X39A (A1P)	PCB connector (auto clean panel)
DS1 (A1P)	DIP switch	X70A (A1P)	PCB connector (auto clean panel)
F1U (A7P)	Fuse B, 5 A 250 V	X*A	PCB connector
F2U (A7P)	Fuse B, 5 A 250 V	X*M	Terminal strip
HAP (A1P)	Running LED (service monitor-green)	X*Y	Connector
H1P (A6P)	LED (On-red)	Z*C	Noise filter (ferrite core)
H2P (A6P)	LED (timer-green)	Z*F	Noise filter
H3P (A6P)	LED (filtersign-red)		* Optional
H4P (A6P)	LED (defrost-orange)		# Field supply
H5P (A6P)	LED (element cleaning-red)		
H6P (A6P)	LED (ventilation cleaning-green)		
KCR (A7P)	Magnetic relay		
KFR (A7P)	Magnetic relay		
KHuR (A7P)	Magnetic relay (Hu)		
K2R	Magnetic relay		
M1F	Fan motor (indoor)		
M1P	Motor (drain pump)		
M*S	Motor (swing flap)		
PS (A1P)	Power supply		
R1T	Thermistor (air)		
R2T	Thermistor (liquid piping)		
R3T	Thermistor (coil)		
RC (A1P)	Signal receiver circuit		
SS1 (A5P)	Selector switch (emergency)		
SS2 (A5P)	Selector switch (wireless address set)		
S1L	Float switch		
TC (A1P)	Signal transmission circuit		

Symbols

X1M	Main terminal
---	Earth wiring
15	Wire number 15
----	Field wire
== ==	Field cable
→ **/12.2	Connection ** continues on page 12 column 2
①	Several wiring possibilities
⋯	Option
⋯	Not mounted in switch box
⋯	Wiring depending on model
□	PCB

Colours

BLK:	Black
WHT:	White
RED:	Red

5.3.2. Outdoor unit

Figure 5-2: Wiring diagram - outdoor unit RZAG-MY1, RZASG-MY1, AZAS-MY1

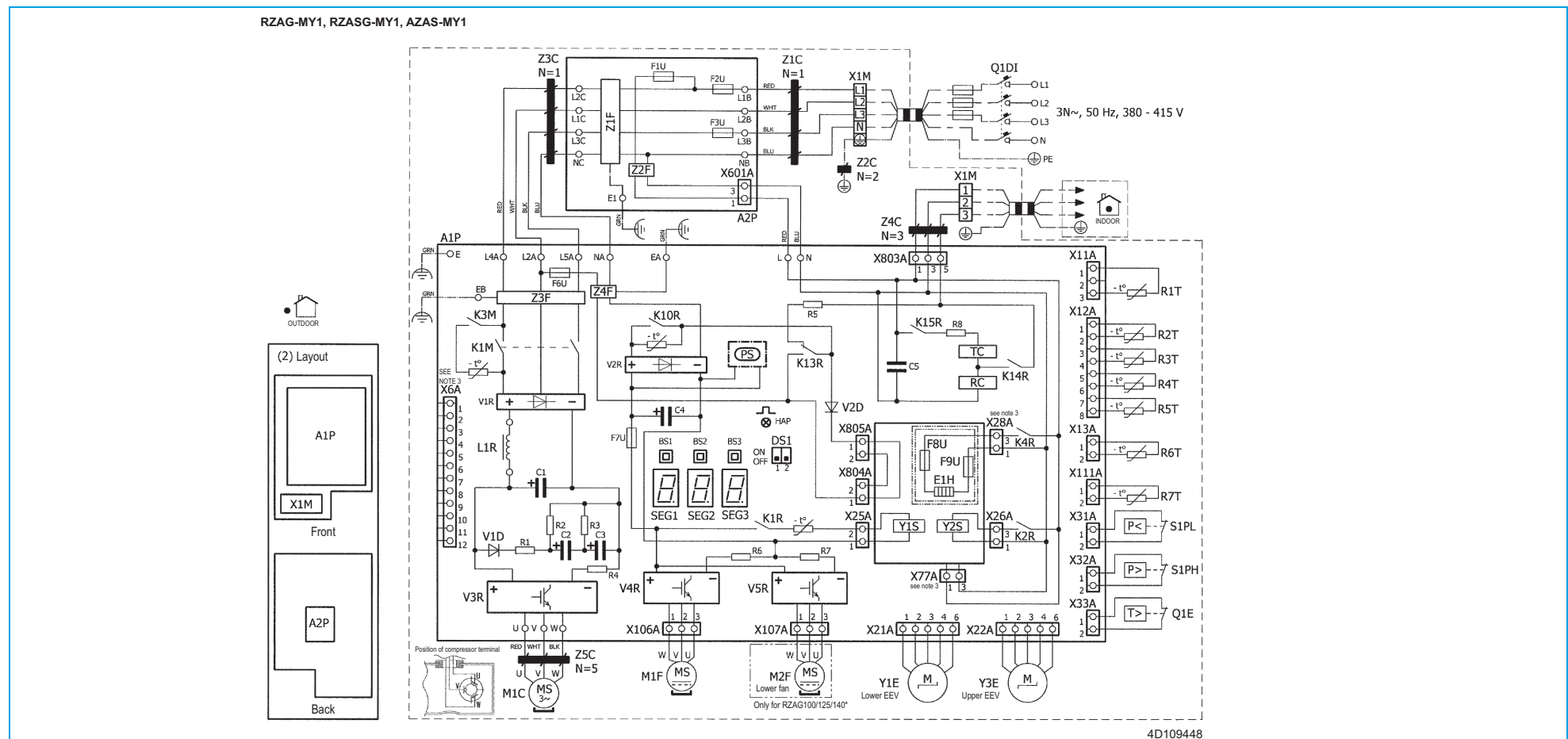

Notes

1. Refer to the wiring diagram sticker (on the back of the front plate) for how to use the BS1-BS3 and DS1 switches.
2. When operating, do not short-circuit protection device(s) S1PH, S1PL and Q1E.
3. Refer to the combination table and the option manual for how to connect the wiring to X6A, X28A and X77A.
4. Colours: BLK: Black, RED: Red, BLU: Blue, WHT: White, GRN: Green.

Legend

A1P	Printed circuit board (main)	R6T	Thermistor (liquid)
A2P	Printed circuit board (noise filter)	R7T	Thermistor (fin)
BS1~BS3 (A1P)	Push-button switch	RC (A1P)	Signal receiver circuit
C1~C5 (A1P)	Capacitor	S1PH	High pressure switch
DS1 (A1P)	Dipswitch	S1PL	Low pressure switch
E1H	* Bottom plate heater	SEG1~SEG3 (A1P)	7-segment display
F1U (A2P)	Fuse T 6,3 A 250 V	TC (A1P)	Signal transmission circuit
F2U, F3U (A2P)	Fuse T 30 A 500 V	V1D, V2D (A1P)	Diode
F6U (A1P)	Fuse T 6,3 A 250 V	V1R, V2R (A1P)	Diode module
F7U (A1P)	Fuse T 5 A 250 V	V3R~V5R (A1P)	IGBT power module
F8U, F9U	Fuse T 1 A 250 V	X1M	Terminal strip
HAP (A1P)	Light-emitting diode (service monitor is green)	Y1E, Y3E	Electronic expansion valve
K1M, K3M (A1P)	Magnetic contactor	Y1S, Y2S	Solenoid valve (4-way valve)
K1R (A1P)	Magnetic relay (Y1S)	Z1C~Z5CS	Noise filter (Ferrite core)
K2R (A1P)	Magnetic relay (Y2S)	Z1F~Z4F (A1P~A2P)	Noise filter
K4R (A1P)	Magnetic relay (E1H)	L*A, L*B, NA, NBE*, U, V, W, X*A (A1P, A2P)	Connector
K10R	Magnetic relay		* Optional
K13R~K15R (A1P)	Magnetic relay		# Field supply
L1R	Reactor		
M1C	Compressor motor		
M1F, M2F	Fan motor		
PS (A1P)	Switching power supply		
Q1DI	Earth leakage circuit breaker (30mA)		
Q1E	Overload protection		
R1~R8 (A1P)	Resistor		
R1T	Thermistor (air)		
R2T	Thermistor (discharge)		
R3T	Thermistor (suction)		
R4T	Thermistor (heat exchanger)		
R5T	Thermistor (heat exchanger middle)		

Symbols

	Connection
	Main terminal
	Earth wiring
	Field supply
	Option
	Switch box
	PCB
	Wiring depending on model
	Protective earth
	Field wire

Figure 5-3: Wiring diagram - outdoor unit AZAS71MV1, RZASG71MV1

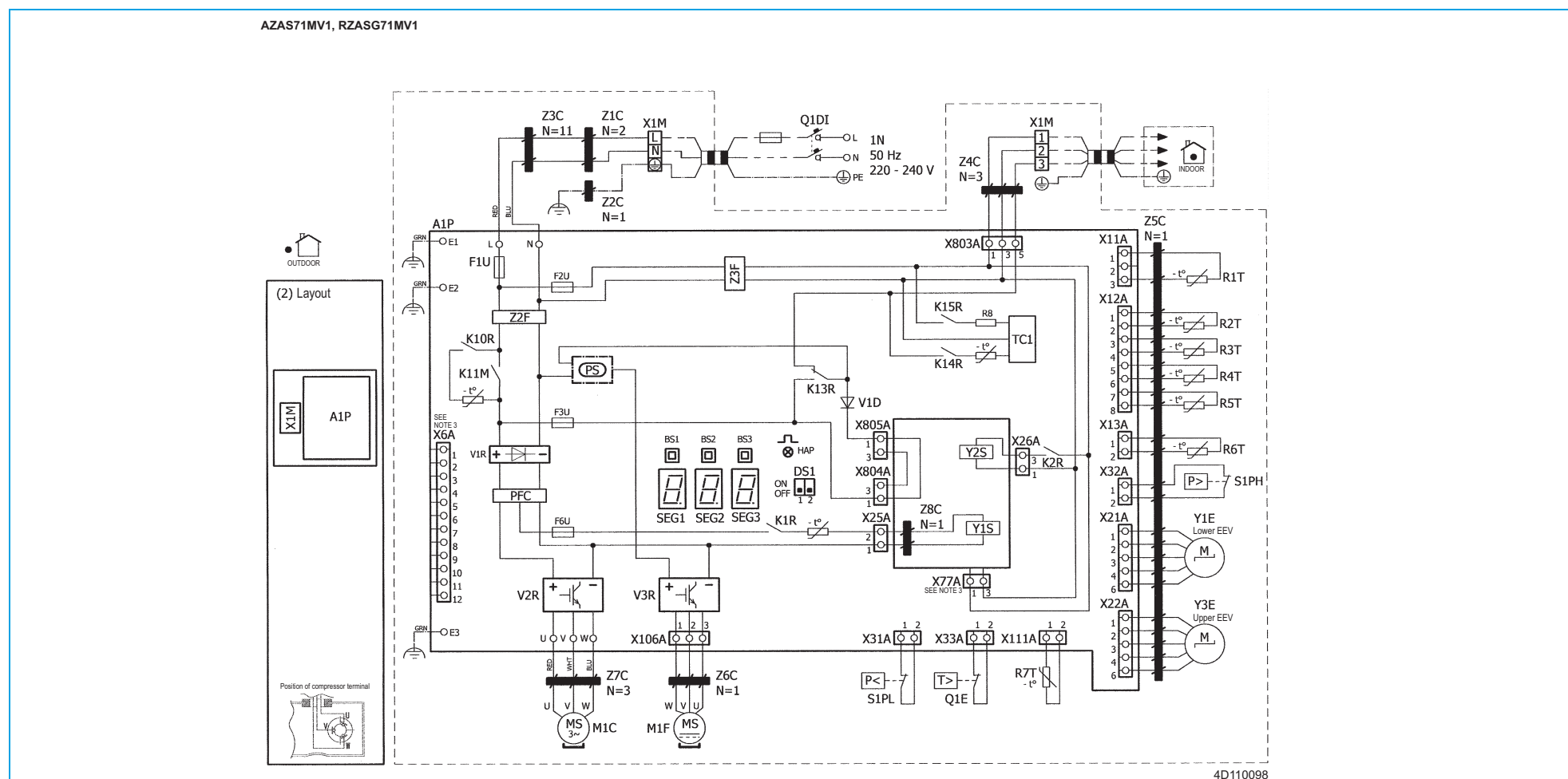

Notes

1. Refer to the wiring diagram sticker (on the back of the front plate) for how to use the BS1~BS3 and DS1 switches.
2. When operating, do not short-circuit protection device(s) S1PH, S1PL and Q1E.
3. Refer to the combination table and the option manual for how to connect the wiring to X6A and X77A.
4. Colours: BLK: Black, RED: Red, BLU: Blue, WHT: White, GRN: Green.

Legend

A1P	Printed circuit board (main)	R8 (A1P)	Resistor
BS1~3 (A1P)	Push-button switch	S1PH	High pressure switch
DS1 (A1P)	Dipswitch	S1PL	Low pressure switch
E1~3 (A1P)	Connector	SEG1~3 (A1P)	7-segment display
F1U (A1P)	Fuse T 31,5 A 250 V	TC1 (A1P)	Signal transceiver circuit
F2U (A1P)	Fuse T 6,3 A 250 V	U, V, W (A1P)	Connector
F3U (A1P)	Fuse T 6,3 A 250 V	V1D (A1P)	Diode
F6U (A1P)	Fuse T 5 A 250 V	V*R (A1P)	Diode module
HAP (A1P)	Light-emitting diode (service monitor is green)	X*A (A1P)	Connector
K1R (A1P)	Magnetic relay (Y1S)	X1M	Terminal strip
K2R (A1P)	Magnetic relay (Y2S)	Y1E, Y3E	Electronic expansion valve
K13R~K15R, K10R (A1P)	Magnetic relay	Y1~2S	Solenoid valve (4-way valve)
K11M (A1P)	Magnetic contactor	Z*C	Noise filter (Ferrite core)
L (A1P)	Connector	Z*F (A1P)	Noise filter
M1C	Compressor motor		* Optional
M1F	Fan motor		# Field supply
N (A1P)	Connector		
PFC (A1P)	Power factor correction		
PS (A1P)	Switching power supply		
Q1DI	Earth leakage circuit breaker (30mA)		
Q1E	Overload protection		
R1T	Thermistor (air)		
R2T	Thermistor (discharge)		
R3T	Thermistor (suction)		
R4T	Thermistor (heat exchanger)		
R5T	Thermistor (heat exchanger middle)		
R6T	Thermistor (liquid)		
R7T	Thermistor (fin)		

Symbols

	Connection
	Main terminal
	Earth wiring
	Field supply
	Option
	Switch box
	PCB
	Wiring depending on model
	Protective earth
	Field wire

Figure 5-4: Wiring diagram - outdoor unit RZAG71MV1, RZASG100MV1, AZAS100MV1

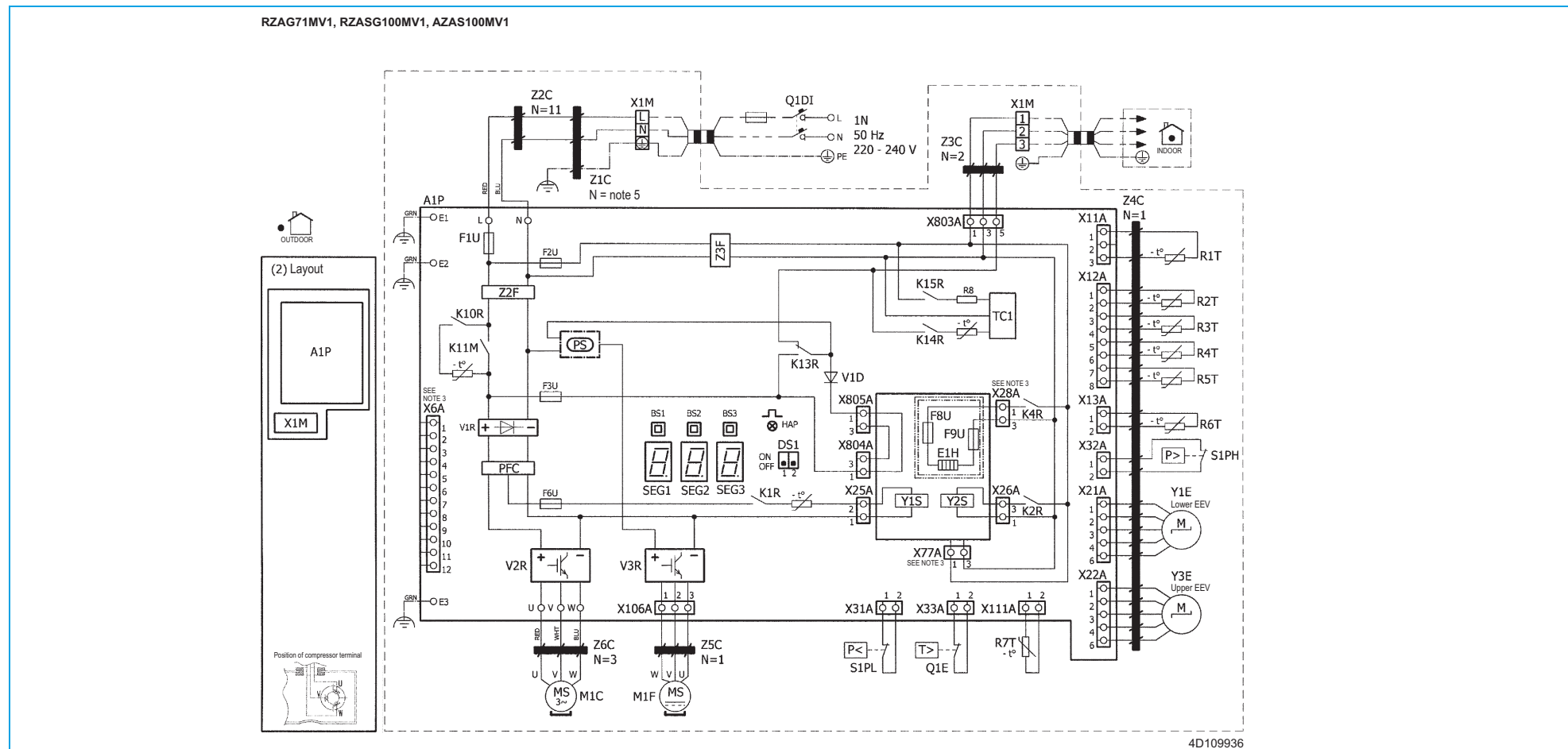

Notes

1. Refer to the wiring diagram sticker (on the back of the front plate) for how to use the BS1-BS3 and DS1 switches.
2. When operating, do not short-circuit protection device(s) S1PH, S1PL and Q1E.
3. Refer to the combination table and the option manual for how to connect the wiring to X6A, X28A and X77A.
4. Colours: BLK: Black, RED: Red, BLU: Blue, WHT: White, GRN: Green.
5. Windings: L-N: 2 - Earth: 1

Legend

A1P	Printed circuit board (main)	R6T	Thermistor (liquid)
BS1~3 (A1P)	Push-button switch	R7T	Thermistor (fin)
DS1 (A1P)	Dipswitch	R8 (A1P)	Resistor
E1~3 (A1P)	Connector	S1PH	High pressure switch
E1H	* Bottom plate heater	S1PL	Low pressure switch
F1U (A1P)	Fuse T 31,5 A 250 V	SEG1~3 (A1P)	7-segment display
F2U (A1P)	Fuse T 6,3 A 250 V	TC1 (A1P)	Signal transceiver circuit
F3U (A1P)	Fuse T 6,3 A 250 V	U, V, W (A1P)	Connector
F6U (A1P)	Fuse T 5 A 250 V	V1D (A1P)	Diode
F8~9U	* Fuse F 1 A 250 V	V*R (A1P)	Diode module
HAP (A1P)	Light-emitting diode (service monitor is green)	X1M	Terminal strip
K1R (A1P)	Magnetic relay (Y1S)	Y1E, Y3E	Electronic expansion valve
K2R (A1P)	Magnetic relay (Y2S)	Y1~2S	Solenoid valve (4-way valve)
K4R (A1P)	Magnetic relay (E1H)	Z*C	Noise filter (Ferrite core)
K13R~K15R, K10R (A1P)	Magnetic relay	Z*F (A1P)	Noise filter
K11M (A1P)	Magnetic contactor		* Optional
L (A1P)	Connector		# Field supply
M1C	Compressor motor		
M1F	Fan motor		
N (A1P)	Connector		
PFC (A1P)	Power factor correction		
PS (A1P)	Switching power supply		
Q1DI	Earth leakage circuit breaker (30mA)		
Q1E	Overload protection		
R1T	Thermistor (air)		
R2T	Thermistor (discharge)		
R3T	Thermistor (suction)		
R4T	Thermistor (heat exchanger)		
R5T	Thermistor (heat exchanger middle)		

Symbols

	Connection
	Main terminal
	Earth wiring
	Field supply
	Option
	Switch box
	PCB
	Wiring depending on model
	Protective earth
	Field wire

Figure 5-5: Wiring diagram - outdoor unit RZAG100-140MV1, RZASG125-140MV1, AZAS125-140MV1

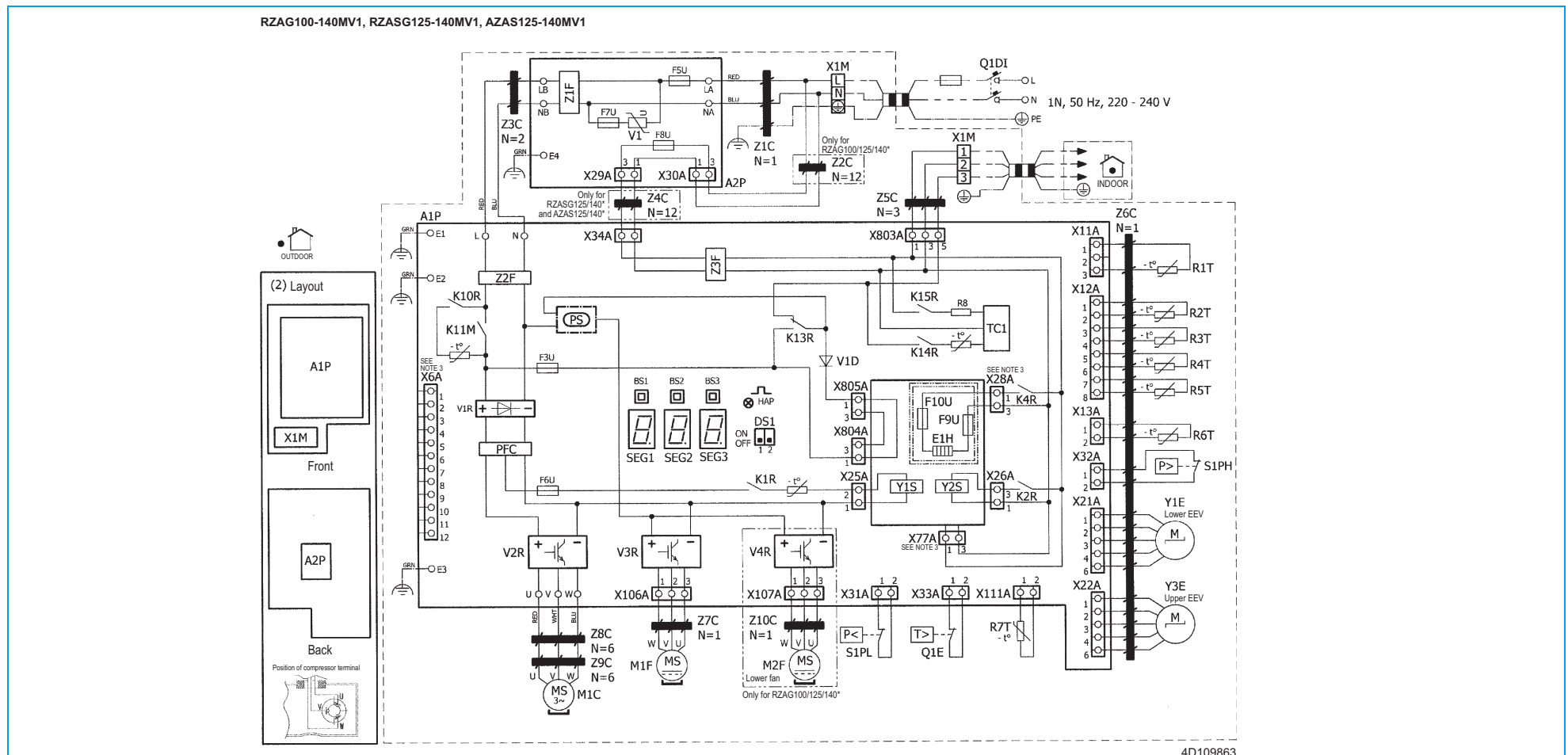

4D109863

Notes

1. Refer to the wiring diagram sticker (on the back of the front plate) for how to use the BSI-BS3 and DS1 switches.
2. When operating, do not short-circuit protection device(s) S1PH, S1PL and Q1E.
3. Refer to the combination table and the option manual for how to connect the wiring to X6A, X28A and X77A.
4. Colours: BLK: Black, RED: Red, BLU: Blue, WHT: White, GRN: Green.

Legend

A1P	Printed circuit board (main)	R7T	Thermistor (fin)
A2P	Printed circuit board (noise filter)	R8 (A1P)	Resistor
BS1~3 (A1P)	Push-button switch	S1PH	High pressure switch
DS1 (A1P)	Dipswitch	S1PL	Low pressure switch
E1~3 (A1-2P)	Connector	SEG1~3 (A1P)	7-segment display
E1H	* Bottom plate heater	TC1 (A1P)	Signal transceiver circuit
F3U (A1P)	Fuse T 6,3 A 250 V	U, V, W (A1P)	Connector
F5U (A2P)	Fuse T 56 A 250 V	V1 (A1P)	Varistor
F6U (A1P)	Fuse T 5 A 250 V	V1D (A1P)	Diode
F7U (A2P)	Fuse T 6,3 A 250 V	V*R (A1P)	Diode module
F8U (A2P)	Fuse T 6,3 A 250 V	X*A (A1~2P)	Connector
F9~10U	* Fuse F 1 A 250 V	X1M	Terminal strip
HAP (A1P)	Light-emitting diode (service monitor is green)	Y1E, Y3E	Electronic expansion valve
K1R (A1P)	Magnetic relay (Y1S)	Y1~2S	Solenoid valve (4-way valve)
K2R (A1P)	Magnetic relay (Y2S)	Z*C	Noise filter (Ferrite core)
K4R (A1P)	Magnetic relay (E1H)	Z*F (A1~2P)	Noise filter
K13R~K15R, K10R (A1P)	Magnetic relay		* Optional
K11M (A1P)	Magnetic contactor		# Field supply
L* (A1-2P)	Connector		
M1C	Compressor motor		
M1~2F	Fan motor		
PFC (A1P)	Power factor correction		
PS (A1P)	Switching power supply		
Q1DI	Earth leakage circuit breaker (30mA)		
Q1E	Overload protection		
R1T	Thermistor (air)		
R2T	Thermistor (discharge)		
R3T	Thermistor (suction)		
R4T	Thermistor (heat exchanger)		
R5T	Thermistor (heat exchanger middle)		
R6T	Thermistor (liquid)		

Symbols

•	Connection
X1M	Main terminal
---	Earth wiring
---	Field supply
⓪	Several wiring possibilities
Ⓧ	Protective earth
⏏	Field wire
⏏	Wiring depending on model
⏏	Option
⏏	Switch box
⏏	PCB

5.3.3. Field wiring

Not applicable.

5.4. Piping diagram

5.4.1. Indoor unit

Figure 5-6: Piping diagram - indoor unit

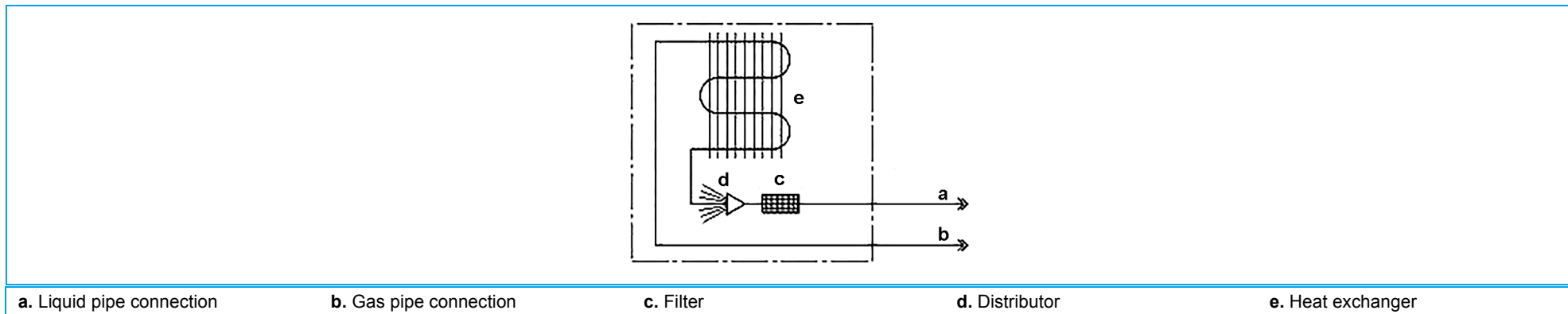

- a. Liquid pipe connection
- b. Gas pipe connection
- c. Filter
- d. Distributor
- e. Heat exchanger

5.4.2. Outdoor unit

Figure 5-7: Piping diagram - outdoor unit

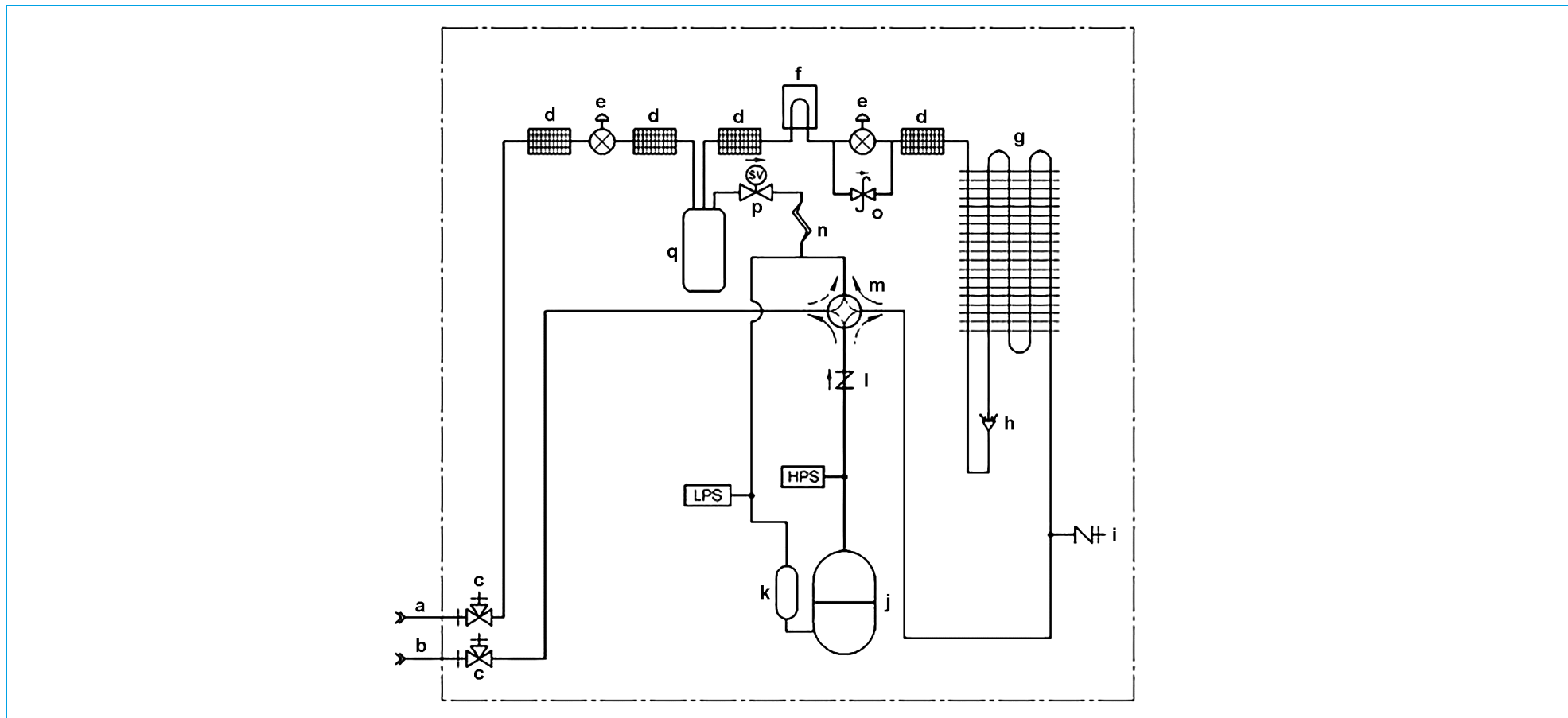

- | | | | |
|----|--|------|-----------------------|
| a. | Field piping (liquid: 09.5 flare connection) | l. | Check valve |
| b. | Field piping (gas: 015.9 flare connection) | m. | 4-way valve |
| c. | Stop valve | n. | Capillary tube |
| d. | Filter (4x) | o. | Pressure relief valve |
| e. | Electronic expansion valve (2x) | p. | Solenoid valve |
| f. | PCB Cooling | q. | Liquid receiver |
| g. | Heat exchanger | HPS | High pressure switch |
| h. | Distributor | LPS | Low pressure switch |
| i. | Service port 5/16" flare | → | Heating |
| j. | Compressor | ---→ | Cooling |
| k. | Compressor accumulator | | |

5.5. Component overview of unit

5.5.1. Indoor unit

Figure 5-8: Components overview - indoor unit

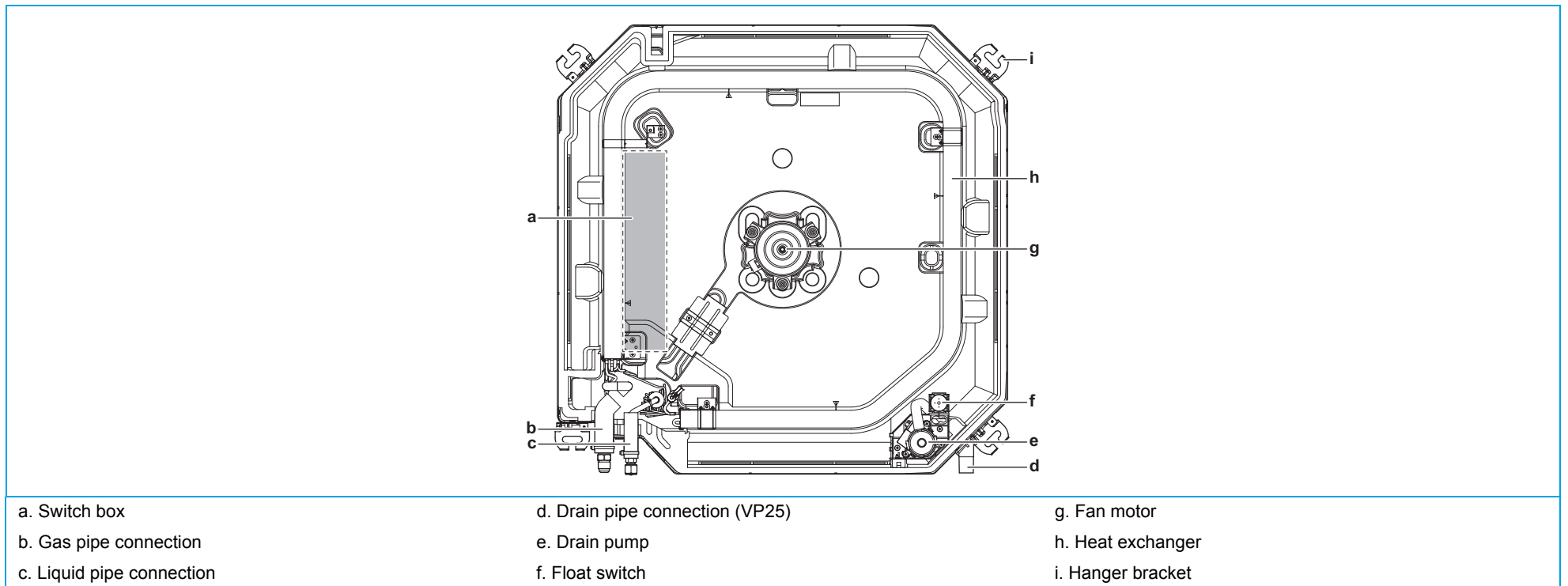

5.5.2. Outdoor unit

Figure 5-9: Components overview - outdoor unit 71

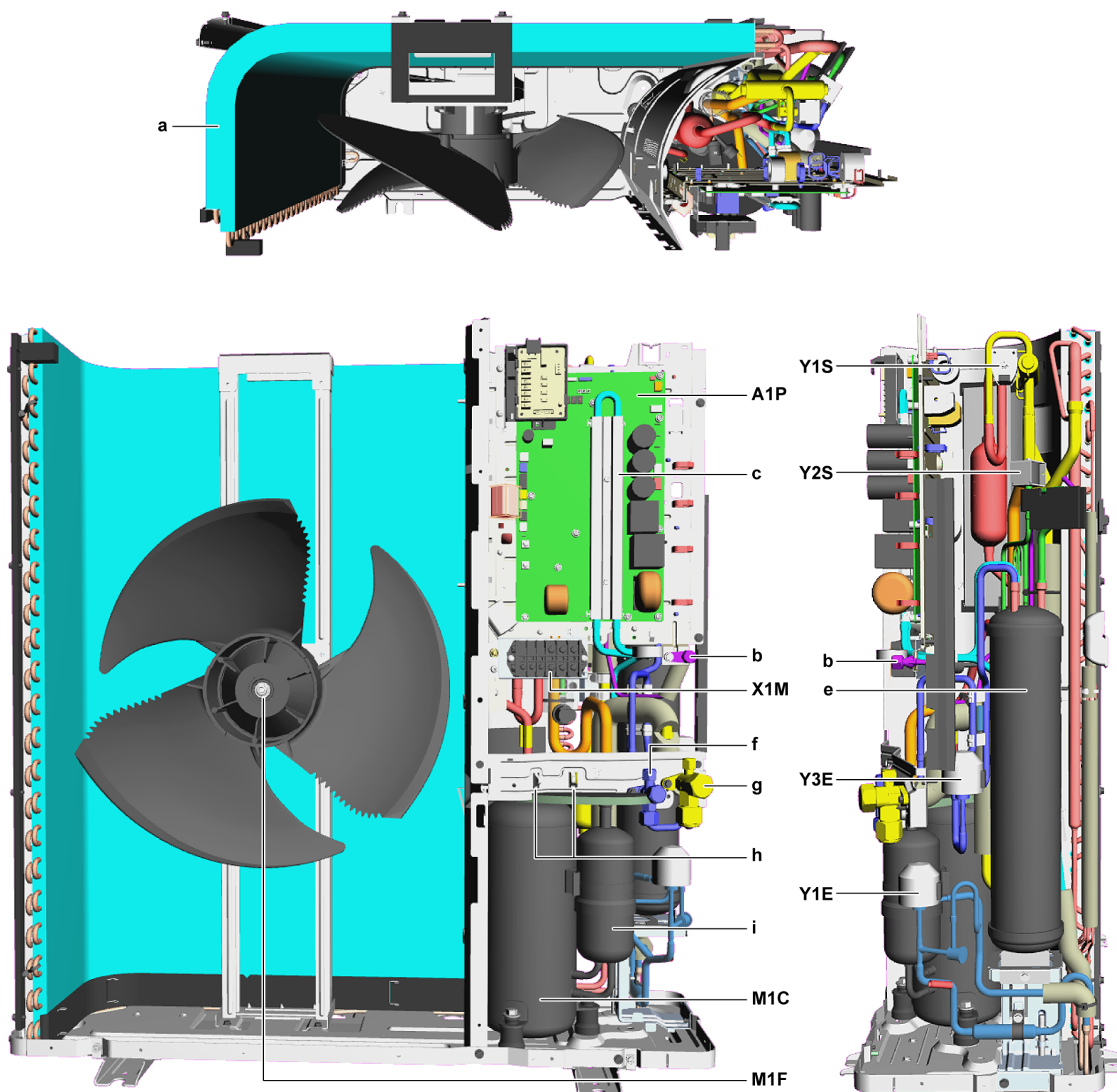

- | | | |
|--|--------|--|
| a. Heat exchanger | A1P | Printed circuit board (main) |
| b. Internal service port | M1C | Motor (compressor) |
| c. Switch box cooling | M1F | Motor (fan) |
| d. Check valve (not visible, located behind compressor) | S1PH-A | Automatic high pressure switch
(not visible, see figure 3-23 "Removing high pressure switch" on page 91) |
| e. Liquid receiver | S1PL | Low pressure switch
(not visible, see figure 3-24 "Removing low pressure switch" on page 93) |
| f. Stop valve with service port (liquid) | X1M | Terminal (communication and power supply) |
| g. Stop valve with service port (gas) | Y1E | Electronic expansion valve |
| h. Cable tie mountings (to fix the field wiring with cable ties to ensure stress relief) | Y3E | Electronic expansion valve |
| i. Compressor accumulator | Y1S | Solenoid valve (4-way valve) |
| | Y2S | Solenoid valve |

Figure 5-10: Components overview - outdoor unit 100-140

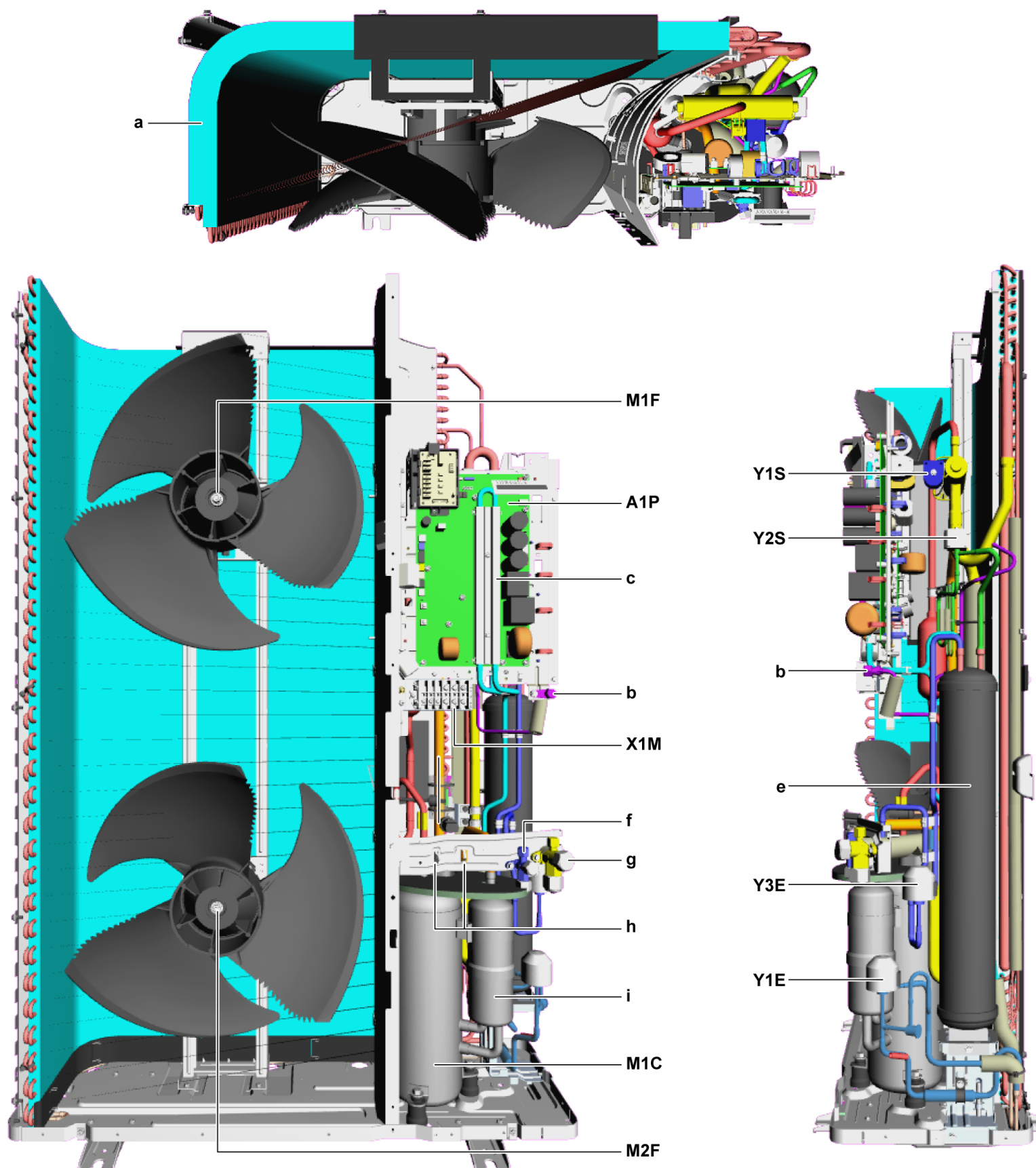

a. Heat exchanger	A1P	Printed circuit board (main)
b. Internal service port	M1C	Motor (compressor)
c. Switch box cooling	M1F	Motor (upper fan)
d. Check valve (not visible, located behind compressor)	M2F	Motor (lower fan)
e. Liquid receiver	S1PH-A	Automatic high pressure switch (not visible, see figure 3-23 "Removing high pressure switch" on page 91)
f. Stop valve with service port (liquid)	S1PL	Low pressure switch (not visible, see figure 3-24 "Removing low pressure switch" on page 93)
g. Stop valve with service port (gas)	X1M	Terminal (communication and power supply)
h. Cable tie mountings (to fix the field wiring with cable ties to ensure stress relief)	Y1E	Electronic expansion valve
i. Compressor accumulator	Y3E	Electronic expansion valve
	Y1S	Solenoid valve (4-way valve)
	Y2S	Solenoid valve

5.6. Product specific information

5.6.1. Error codes

5.6.1.1. "E9-00" - Electronic expansion valve abnormality

Trigger conditions

- A = 4 K
- B = 10 K

5.6.1.2. "F3-00" - Discharge pipe temperature abnormality

Compressor	A (°C)	B (°C)	C (°C)
2YC71	120	110	/
2YC100	120	110	/

5.6.2. Component checklist

5.6.2.1. How to activate inverter test

Not available yet.

5.6.2.2. Component checklist

Component	Component name	Connector on 71-class	Connector on 100/140-class	PCB	Specific
Outdoor unit					
M1C	Motor (compressor)	X502A	X502A	A1P	
M1F	Motor (upper fan)	X106A	X106A	A1P	
M2F	Motor (lower fan)		X107A	A1P	
S1PH-A	Automatic high pressure switch	X32A	X32A	A1P	
S1PH-M	Manual high pressure switch	X32A	X32A	A1P	
S1PL	Low pressure switch	X31A	X31A	A1P	
Y1E	Electronic expansion valve	X21A	X21A	A1P	
Y3E	Electronic expansion valve	X22A	X22A	A1P	
Y1S	Solenoid valve (4-way valve)	X25A	X25A	A1P	
Y2S	Solenoid valve	X26A	X26A	A1P	
R1T	Thermistor (air)	X11A	X11A	A1P	Type 1
R2T	Thermistor (discharge)	X12A	X12A	A1P	Type 3
R3T	Thermistor (suction)	X12A	X12A	A1P	Type 1
R4T	Thermistor (heat exchanger inlet)	X12A	X12A	A1P	Type 1
R5T	Thermistor (heat exchanger middle)	X12A	X12A	A1P	Type 1
R6T	Thermistor (liquid)	X13A	X13A	A1P	Type 1

5.7. Switch box

5.7.1. Indoor unit

Not applicable.

5.7.2. Outdoor unit

Not applicable.

5.8. Field information report

See next page.

In case a problem occurred on the unit which could not be resolved by using the content of this service manual or in case you have a problem which could be resolved but of which the manufacturer should be notified, we advise you to contact your distributor.

To facilitate the investigation, additional information is required. Please fill out the following form before contacting your distributor.



FIELD INFORMATION REPORT

Key person info	
Name:	Company name:
Your contact details Phone number:	E-mail address:
Site address:	
Your reference:	Date of visit:

Claim info	
Title:	
Problem description:	
Error code:	Trouble date:
Problem frequency:	
Investigation steps done:	
Insert picture of the trouble.	
Current situation (solved, not solved, ...):	
Countermeasures taken:	
Comments and proposals:	
Part available for return (if applicable):	

Application info

Application (house, apartment, office, ...):

New project or refurbishment:

Heat emitters (radiators / under floor heating / fan coils / ...):

Hydraulic layout (simple schematic):

Unit / Installation info

Model name:

Serial number:

Installation / commissioning date:

Software version hydro PCB A1P:

Software version hydro PCB A5P:

Software version user interface:

Software version outdoor PCB:

Minimum water volume:

Maximum water volume:

Brine composition and mixture:

Brine freeze up temperature:

Space heating control (leaving water temperature, room thermostat, ext. room thermostat):

Space heating setpoint:

Domestic hot water control (reheat only, schedule only, reheat + schedule):

Domestic hot water setpoint:

Provide pictures of the field settings overview (viewable on the user interface).