

DAIKIN

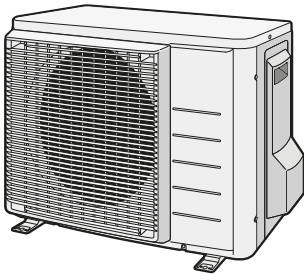

Installation manual

R32 split series



ARXM25N2V1B9
ARXM35N2V1B9

RXM20N2V1B9
RXM25N2V1B9
RXM35N2V1B9

RXJ20M3V1B
RXJ25M3V1B
RXJ35M3V1B

RXA20A3V1B
RXA25A3V1B
RXA35A3V1B

Installation manual
R32 split series

English

Table of contents

1	About the documentation	4
1.1	About this document.....	4
2	About the box	4
2.1	Outdoor unit.....	4
2.1.1	To remove the accessories from the outdoor unit.....	4
3	Preparation	4
3.1	Preparing the installation site	4
3.1.1	Installation site requirements of the outdoor unit	4
3.1.2	Additional installation site requirements of the outdoor unit in cold climates	5
3.1.3	Refrigerant piping length and height difference	5
4	Installation	5
4.1	Mounting the outdoor unit.....	5
4.1.1	To provide the installation structure	5
4.1.2	To install the outdoor unit.....	6
4.1.3	To provide drainage	6
4.2	Connecting the refrigerant piping	6
4.2.1	To connect the refrigerant piping to the outdoor unit ..	6
4.3	Checking the refrigerant piping	6
4.3.1	To check for leaks.....	6
4.3.2	To perform vacuum drying.....	7
4.4	Charging refrigerant	7
4.4.1	About charging refrigerant	7
4.4.2	About the refrigerant	7
4.4.3	To determine the additional refrigerant amount.....	8
4.4.4	To determine the complete recharge amount.....	8
4.4.5	To charge additional refrigerant.....	8
4.4.6	To fix the fluorinated greenhouse gases label	8
4.5	Connecting the electrical wiring.....	8
4.5.1	Specifications of standard wiring components.....	9
4.5.2	To connect the electrical wiring on the outdoor unit....	9
4.6	Finishing the outdoor unit installation	9
4.6.1	To finish the outdoor unit installation	9
5	Commissioning	9
5.1	Checklist before commissioning.....	9
5.2	Checklist during commissioning	10
5.3	To perform a test run.....	10
6	Troubleshooting	10
6.1	Fault diagnosis using LED on outdoor unit PCB	10
7	Disposal	10
8	Technical data	11
8.1	Wiring diagram	11

1 About the documentation

1.1 About this document



INFORMATION

Make sure that the user has the printed documentation and ask him/her to keep it for future reference.

Target audience

Authorised installers

Documentation set

This document is part of a documentation set. The complete set consists of:

- **General safety precautions:**
 - Safety instructions that you **MUST** read before installing
 - Format: Paper (in the box of the outdoor unit)
- **Outdoor unit installation manual:**
 - Installation instructions
 - Format: Paper (in the box of the outdoor unit)
- **Installer reference guide:**
 - Preparation of the installation, reference data,...
 - Format: Digital files on <http://www.daikineurope.com/support-and-manuals/product-information/>

Latest revisions of the supplied documentation may be available on the regional Daikin website or via your dealer.

The original documentation is written in English. All other languages are translations.

Technical engineering data

- A **subset** of the latest technical data is available on the regional Daikin website (publicly accessible).
- The **full set** of latest technical data is available on the Daikin extranet (authentication required).

2 About the box

2.1 Outdoor unit

2.1.1 To remove the accessories from the outdoor unit

- 1 Lift the outdoor unit.
- 2 Remove the accessories at the bottom of the package.

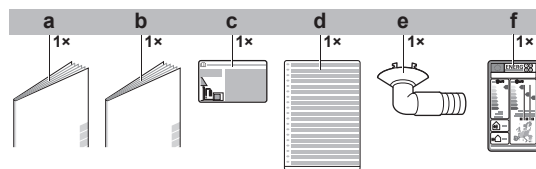

- a General safety precautions
- b Outdoor unit installation manual
- c Fluorinated greenhouse gases label
- d Multilingual fluorinated greenhouse gases label
- e Drain plug (located on the bottom of the packing case)
- f Energy label

3 Preparation

3.1 Preparing the installation site



WARNING

The appliance shall be stored in a room without continuously operating ignition sources (example: open flames, an operating gas appliance or an operating electric heater).

3.1.1 Installation site requirements of the outdoor unit

Mind the following spacing guidelines:

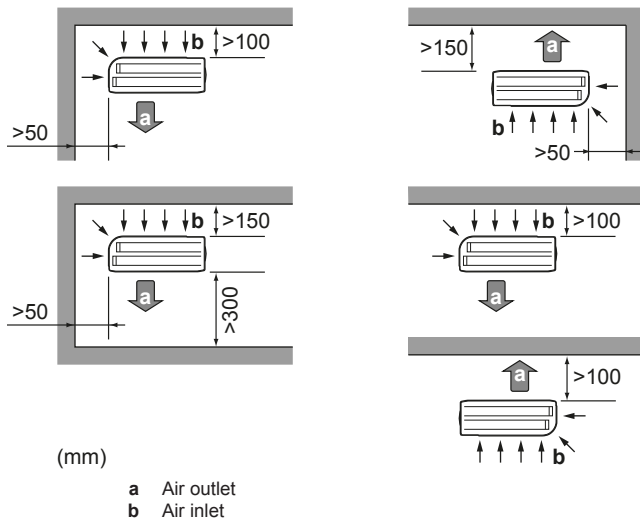

(mm)

- a Air outlet
- b Air inlet



NOTICE

The height of the wall on the outlet side of the outdoor unit **MUST** be ≤ 1200 mm.

It is recommended to install a baffle plate when the air outlet is exposed to wind.

It is recommended to install the outdoor unit with the air inlet facing the wall and **NOT** directly exposed to the wind.

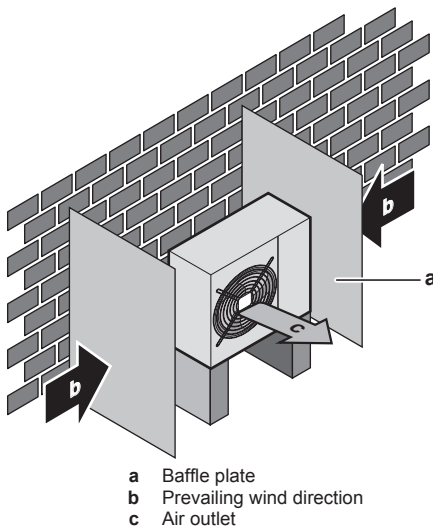

- a Baffle plate
- b Prevailing wind direction
- c Air outlet

Do **NOT** install the unit in sound sensitive areas (e.g. near a bedroom), so that the operation noise will cause no trouble.

Note: If the sound is measured under actual installation conditions, the measured value might be higher than the sound pressure level mentioned in "Sound spectrum" in the data book due to environmental noise and sound reflections.



INFORMATION

The sound pressure level is less than 70 dBA.

3.1.2 Additional installation site requirements of the outdoor unit in cold climates

Protect the outdoor unit against direct snowfall and take care that the outdoor unit is **NEVER** snowed up.

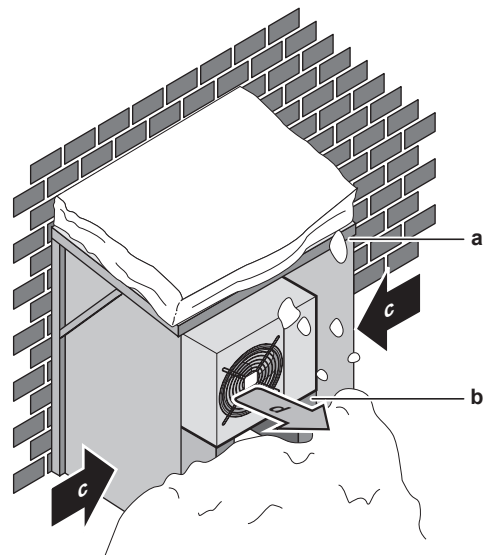

- a Snow cover or shed
- b Pedestal
- c Prevailing wind direction
- d Air outlet

In any case, provide at least 300 mm of free space below the unit. Additionally, make sure the unit is positioned at least 100 mm above the maximum expected level of snow. See "4.1 Mounting the outdoor unit" on page 5 for more details.

In heavy snowfall areas it is very important to select an installation site where the snow will **NOT** affect the unit. If lateral snowfall is possible, make sure that the heat exchanger coil is **NOT** affected by the snow. If necessary, install a snow cover or shed and a pedestal.

3.1.3 Refrigerant piping length and height difference

What?	Distance
Maximum allowable pipe length	20 m
Minimum allowable pipe length	1.5 m
Maximum allowable height difference	15 m

4 Installation

4.1 Mounting the outdoor unit

4.1.1 To provide the installation structure

Use a vibration-proof rubber (field supply) in cases where vibrations may be transmitted to the building.

Prepare 4 sets of M8 or M10 anchor bolts, nuts and washers (field supply).

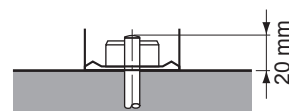

4 Installation

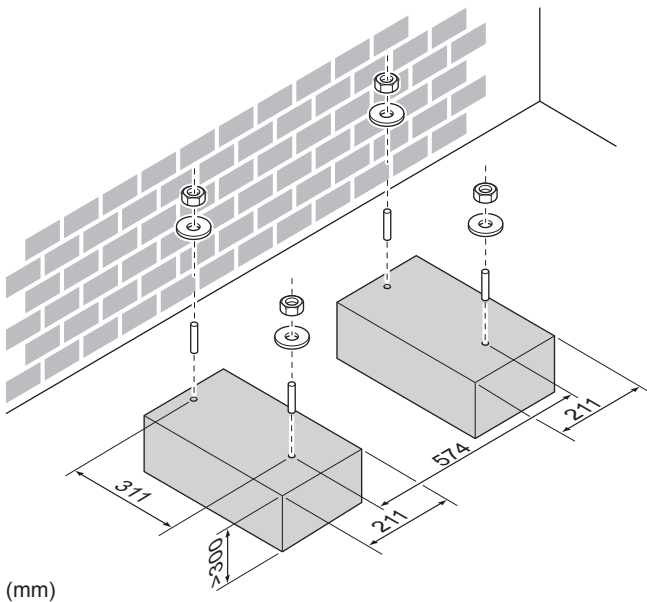

In any case, provide at least 300 mm of free space below the unit. Additionally, make sure the unit is positioned at least 100 mm above the maximum expected level of snow. In this case, it is recommended to construct a pedestal.

4.1.2 To install the outdoor unit

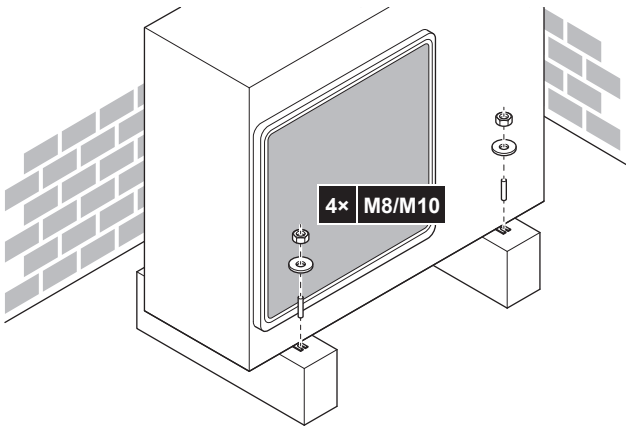

4.1.3 To provide drainage

NOTICE

If the unit is installed in a cold climate, take adequate measures so that the evacuated condensate CANNOT freeze.

INFORMATION

For information on the available options, contact your dealer.

NOTICE

Provide at least 300 mm of free space below the unit. Additionally, make sure the unit is positioned at least 100 mm above the expected level of snow.

- 1 Use a drain plug for drainage.
- 2 Use a $\varnothing 16$ mm hose (field supply).

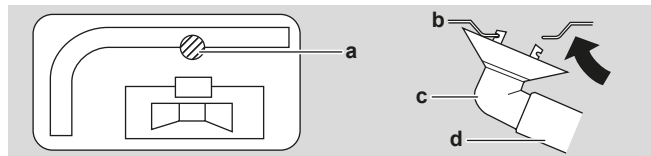

- a Drain port
- b Bottom frame
- c Drain plug
- d Hose (field supply)

4.2 Connecting the refrigerant piping

⚠ DANGER: RISK OF BURNING

4.2.1 To connect the refrigerant piping to the outdoor unit

- **Piping length.** Keep field piping as short as possible.
- **Piping protection.** Protect the field piping against physical damage.

⚠ WARNING

Connect the refrigerant piping securely before running the compressor. If the refrigerant piping is NOT connected and the stop valve is open when the compressor is run, air will be sucked in. This will cause abnormal pressure in the refrigeration cycle, which may result in equipment damage and even injury.

⚠ CAUTION

- Use the flare nut fixed to the unit.
- To prevent gas leakage, apply refrigeration oil only to the inside of the flare. Use refrigeration oil for R32.
- Do NOT reuse joints.

- 1 Connect the liquid refrigerant connection from the indoor unit to the liquid stop valve of the outdoor unit.

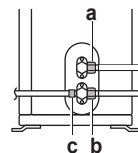

- a Liquid stop valve
- b Gas stop valve
- c Service port

- 2 Connect the gas refrigerant connection from the indoor unit to the gas stop valve of the outdoor unit.

⚠ NOTICE

It is recommended that the refrigerant piping between indoor and outdoor unit is installed in a ducting or the refrigerant piping is wrapped with finishing tape.

4.3 Checking the refrigerant piping

4.3.1 To check for leaks

⚠ NOTICE

Do NOT exceed the unit's maximum working pressure (see "PS High" on the unit name plate).



NOTICE

Make sure to use a recommended bubble test solution from your wholesaler. Do not use soap water, which may cause cracking of flare nuts (soap water may contain salt, which absorbs moisture that will freeze when the piping gets cold), and/or lead to corrosion of flared joints (soap water may contain ammonia which causes a corrosive effect between the brass flare nut and the copper flare).

- 1 Charge the system with nitrogen gas up to a gauge pressure of at least 200 kPa (2 bar). It is recommended to pressurize to 3000 kPa (30 bar) in order to detect small leaks.
- 2 Check for leaks by applying the bubble test solution to all connections.
- 3 Discharge all nitrogen gas.

4.3.2 To perform vacuum drying



DANGER: RISK OF EXPLOSION

Do NOT start the unit if it is vacuumed.

- 1 Vacuum the system until the pressure on the manifold indicates -0.1 MPa (-1 bar).
- 2 Leave as is for 4-5 minutes and check the pressure:

If the pressure...	Then...
Does not change	There is no moisture in the system. This procedure is finished.
Increases	There is moisture in the system. Go to the next step.

- 3 Vacuum the system for at least 2 hours to a manifold pressure of -0.1 MPa (-1 bar).
- 4 After turning the pump OFF, check the pressure for at least 1 hour.
- 5 If you do NOT reach the target vacuum or CANNOT maintain the vacuum for 1 hour, do the following:
 - Check for leaks again.
 - Perform vacuum drying again.



NOTICE

Make sure to open the stop valves after installing the refrigerant piping and performing vacuum drying. Running the system with the stop valves closed may break the compressor.

4.4 Charging refrigerant

4.4.1 About charging refrigerant

The outdoor unit is factory charged with refrigerant, but in some cases the following might be necessary:

What	When
Charging additional refrigerant	When the total liquid piping length is more than specified (see later).
Completely recharging refrigerant	Example: <ul style="list-style-type: none"> ▪ When relocating the system. ▪ After a leak.

Charging additional refrigerant

Before charging additional refrigerant, make sure the outdoor unit's **external** refrigerant piping is checked (leak test, vacuum drying).



INFORMATION

Depending on the units and/or the installation conditions, it might be necessary to connect electrical wiring before you can charge refrigerant.

Typical workflow – Charging additional refrigerant typically consists of the following stages:

- 1 Determining if and how much you have to charge additionally.
- 2 If necessary, charging additional refrigerant.
- 3 Filling in the fluorinated greenhouse gases label, and fixing it to the inside of the outdoor unit.

Completely recharging refrigerant

Before completely recharging refrigerant, make sure the following is done:

- 1 All refrigerant is recovered from the system.
- 2 The outdoor unit's **external** refrigerant piping is checked (leak test, vacuum drying).
- 3 Vacuum drying on the outdoor unit's **internal** refrigerant piping is performed.



NOTICE

Before completely recharging, perform vacuum drying on the outdoor unit's **internal** refrigerant piping as well.

Typical workflow – Completely recharging refrigerant typically consists of the following stages:

- 1 Determining how much refrigerant to charge.
- 2 Charging refrigerant.
- 3 Filling in the fluorinated greenhouse gases label, and fixing it to the inside of the outdoor unit.

4.4.2 About the refrigerant

This product contains fluorinated greenhouse gases. Do NOT vent gases into the atmosphere.

Refrigerant type: R32

Global warming potential (GWP) value: 675



WARNING: FLAMMABLE MATERIAL

The refrigerant inside this unit is mildly flammable.



WARNING

The appliance shall be stored in a room without continuously operating ignition sources (example: open flames, an operating gas appliance or an operating electric heater).



WARNING

- Do NOT pierce or burn refrigerant cycle parts.
- Do NOT use cleaning materials or means to accelerate the defrosting process other than those recommended by the manufacturer.
- Be aware that the refrigerant inside the system is odourless.

4 Installation

WARNING

The refrigerant inside the unit is mildly flammable, but normally does NOT leak. If the refrigerant leaks in the room and comes in contact with fire from a burner, a heater, or a cooker, this may result in fire, or the formation of a harmful gas.

Turn off any combustible heating devices, ventilate the room, and contact the dealer where you purchased the unit.

Do NOT use the unit until a service person confirms that the part from which the refrigerant leaked has been repaired.

4.4.3 To determine the additional refrigerant amount

If the total liquid piping length is...	Then...
≤10 m	Do NOT add additional refrigerant.
>10 m	R=(total length (m) of liquid piping-10 m)×0.020 R=Additional charge (kg) (rounded in units of 0.1 kg)

INFORMATION

Piping length is the one-way length of liquid piping.

4.4.4 To determine the complete recharge amount

INFORMATION

If a complete recharge is necessary, the total refrigerant charge is: the factory refrigerant charge (see unit name plate) + the determined additional amount.

4.4.5 To charge additional refrigerant

WARNING

- Only use R32 as refrigerant. Other substances may cause explosions and accidents.
- R32 contains fluorinated greenhouse gases. Its global warming potential (GWP) value is 675. Do NOT vent these gases into the atmosphere.
- When charging refrigerant, ALWAYS use protective gloves and safety glasses.

Prerequisite: Before charging refrigerant, make sure the refrigerant piping is connected and checked (leak test and vacuum drying).

- Connect the refrigerant cylinder to the service port.
- Charge the additional refrigerant amount.
- Open the gas stop valve.

4.4.6 To fix the fluorinated greenhouse gases label

- Fill in the label as follows:

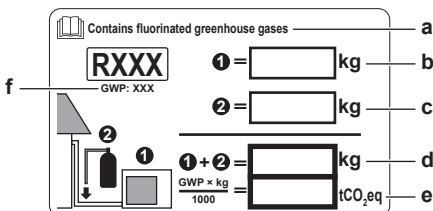

- If a multilingual fluorinated greenhouse gases label is delivered with the unit (see accessories), peel off the applicable language and stick it on top of a.
- Factory refrigerant charge: see unit name plate
- Additional refrigerant amount charged
- Total refrigerant charge
- Quantity of fluorinated greenhouse gases** of the total refrigerant charge expressed as tonnes CO₂ equivalent.
- GWP = Global warming potential

NOTICE

Applicable legislation on **fluorinated greenhouse gases** requires that the refrigerant charge of the unit is indicated both in weight and CO₂ equivalent.

Formula to calculate the quantity in CO₂ equivalent tonnes: GWP value of the refrigerant × total refrigerant charge [in kg] / 1000

Use the GWP value mentioned on the refrigerant charge label. That GWP is based on the current legislation on fluorinated greenhouse gases. The GWP mentioned in the manual might be outdated.

- Fix the label on the inside of the outdoor unit near the gas and liquid stop valves.

4.5 Connecting the electrical wiring

DANGER: RISK OF ELECTROCUTION

WARNING

- All wiring MUST be performed by an authorised electrician and MUST comply with the applicable legislation.
- Make electrical connections to the fixed wiring.
- All components procured on-site and all electrical construction MUST comply with the applicable legislation.

WARNING

ALWAYS use multicore cable for power supply cables.

WARNING

Use an all-pole disconnection type breaker with at least 3 mm between the contact point gaps that provide full disconnection under overvoltage category III.

WARNING

If the supply cord is damaged, it MUST be replaced by the manufacturer, its service agent or similarly qualified persons in order to avoid a hazard.

WARNING

Do NOT connect the power supply to the indoor unit. This could result in electrical shock or fire.

WARNING

- Do NOT use locally purchased electrical parts inside the product.
- Do NOT branch the power supply for the drain pump, etc. from the terminal block. This could result in electrical shock or fire.

WARNING

Keep the interconnection wiring away from copper pipes without thermal insulation as such pipes will be very hot.



DANGER: RISK OF ELECTROCUTION

All electrical parts (including thermistors) are powered by the power supply. Do not touch them with bare hands.



DANGER: RISK OF ELECTROCUTION

Disconnect the power supply for more than 10 minutes, and measure the voltage at the terminals of main circuit capacitors or electrical components before servicing. The voltage **MUST** be less than 50 V DC before you can touch electrical components. For the location of the terminals, see the wiring diagram.

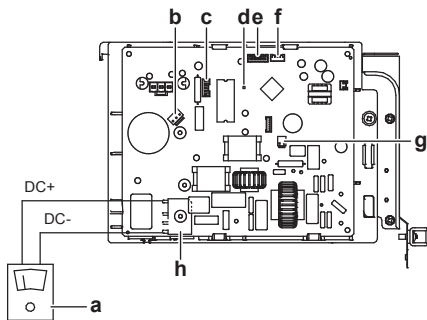

- a Multimeter (DC voltage range)
- b S80 – reversing solenoid valve lead wire
- c S70 – fan motor lead wire
- d LED
- e S90 – thermistor lead wire
- f S20 – electronic expansion valve lead wire
- g S40 – thermal overload relay lead wire
- h DB1 - diode bridge

4.5.1 Specifications of standard wiring components

Component	Class 20	Class 25+35
Power supply cable	Voltage	220~240 V
	Phase	1~
	Frequency	50 Hz
	Wire sizes	3-core cable 2.5 mm ² ~4.0 mm ² H05RN-F (60245 IEC 57)
Interconnection cable (indoor↔outdoor)	4-core cable 1.5 mm ² ~2.5 mm ² and applicable for 220~240 V H05RN-F (60245 IEC 57)	
Recommended circuit breaker	10 A	13 A
Earth leakage circuit breaker	MUST comply with applicable legislation	

4.5.2 To connect the electrical wiring on the outdoor unit

- 1 Remove the service cover.
- 2 Open the wire clamp.
- 3 Connect the interconnection cable and power supply as follows:

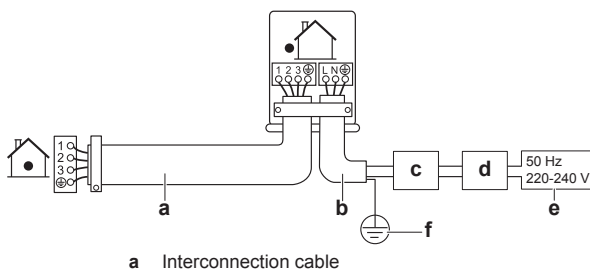

a Interconnection cable

- b Power supply cable
- c Circuit breaker
- d Earth leakage circuit breaker
- e Power supply
- f Earth

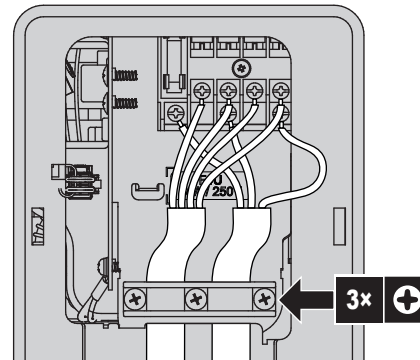

- 4 Tighten the terminal screws securely. We recommend using a Phillips screwdriver.

4.6 Finishing the outdoor unit installation

4.6.1 To finish the outdoor unit installation



DANGER: RISK OF ELECTROCUTION

- Make sure that the system is earthed properly.
- Turn off the power supply before servicing.
- Install the service cover before turning on the power supply.

- 1 Insulate and fix the refrigerant piping and interconnection cable as follows:

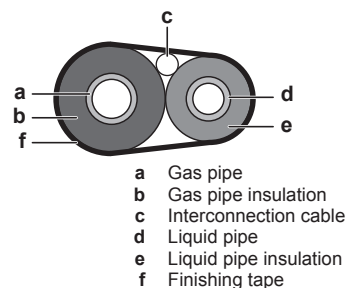

- 2 Install the service cover.

5 Commissioning



NOTICE

NEVER operate the unit without thermistors and/or pressure sensors/switches. Burning of the compressor might result.

5.1 Checklist before commissioning

After the installation of the unit, first check the following items. Once all below checks are fulfilled, the unit **MUST** be closed, **ONLY** then can the unit be powered up.

<input type="checkbox"/>	The indoor unit is properly mounted.
<input type="checkbox"/>	The outdoor unit is properly mounted.
<input type="checkbox"/>	The system is properly earthed and the earth terminals are tightened.

6 Troubleshooting

<input type="checkbox"/>	The power supply voltage matches the voltage on the identification label of the unit.
<input type="checkbox"/>	There are NO loose connections or damaged electrical components in the switch box.
<input type="checkbox"/>	There are NO damaged components or squeezed pipes on the inside of the indoor and outdoor units.
<input type="checkbox"/>	There are NO refrigerant leaks .
<input type="checkbox"/>	The refrigerant pipes (gas and liquid) are thermally insulated.
<input type="checkbox"/>	The correct pipe size is installed and the pipes are properly insulated.
<input type="checkbox"/>	The stop valves (gas and liquid) on the outdoor unit are fully open.
<input type="checkbox"/>	The following field wiring has been carried out according to this document and the applicable legislation between the outdoor unit and the indoor unit.
<input type="checkbox"/>	Drainage Make sure drainage flows smoothly. Possible consequence: Condensate water might drip.
<input type="checkbox"/>	The indoor unit receives the signals of the user interface .
<input type="checkbox"/>	The specified wires are used for the interconnection cable .
<input type="checkbox"/>	The fuses, circuit breakers , or locally installed protection devices are installed according to this document, and have NOT been bypassed.

5.2 Checklist during commissioning

<input type="checkbox"/>	To perform an air purge .
<input type="checkbox"/>	To perform a test run .

5.3 To perform a test run

Prerequisite: Power supply MUST be in the specified range.

Prerequisite: Test run may be performed in cooling or heating mode.

Prerequisite: Test run should be performed in accordance with the operation manual of the indoor unit to make sure that all functions and parts are working properly.



- 1 In cooling mode, select the lowest programmable temperature. In heating mode, select the highest programmable temperature. Test run can be disabled if necessary.
- 2 When the test run is finished, set the temperature to a normal level. In cooling mode: 26~28°C, in heating mode: 20~24°C.
- 3 The system stops operating 3 minutes after the unit is turned OFF.

INFORMATION

- Even if the unit is turned OFF, it consumes electricity.
- When the power turns back on after a power break, the previously selected mode will be resumed.

6 Troubleshooting

6.1 Fault diagnosis using LED on outdoor unit PCB

LED is...	Diagnosis
 flashing	Normal. <ul style="list-style-type: none"> ▪ Check the indoor unit.
 ON	<ul style="list-style-type: none"> ▪ Turn the power OFF and back ON, and check the LED within approximately 3 minutes. If the LED is ON again, the outdoor unit PCB is faulty.
 OFF	<ol style="list-style-type: none"> 1 Supply voltage (for power saving). 2 Power supply fault. 3 Turn the power OFF and back ON, and check the LED within approximately 3 minutes. If the LED is ON again, the outdoor unit PCB is faulty.



DANGER: RISK OF ELECTROCUTION

- When the unit is not operating, the LEDs on the PCB are turned off in order to save power.
- Even when the LEDs are off, the terminal block and the PCB may be powered.

7 Disposal

















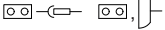

NOTICE

Do NOT try to dismantle the system yourself: dismantling of the system, treatment of the refrigerant, oil and other parts MUST comply with applicable legislation. Units MUST be treated at a specialised treatment facility for reuse, recycling and recovery.

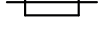
8 Technical data

A **subset** of the latest technical data is available on the regional Daikin website (publicly accessible). The **full set** of latest technical data is available on the Daikin extranet (authentication required).

8.1 Wiring diagram

Unified Wiring Diagram Legend			
For applied parts and numbering, refer to the wiring diagram on the unit. Part numbering is by Arabic numbers in ascending order for each part and is represented in the overview below by symbol "*" in the part code.			
	: CIRCUIT BREAKER		: PROTECTIVE EARTH
	: CONNECTION		: PROTECTIVE EARTH (SCREW)
	: CONNECTOR		: RECTIFIER
	: EARTH		: RELAY CONNECTOR
	: FIELD WIRING		: SHORT-CIRCUIT CONNECTOR
	: FUSE		: TERMINAL
	: INDOOR UNIT		: TERMINAL STRIP
	: OUTDOOR UNIT		: WIRE CLAMP
BLK : BLACK	GRN : GREEN	PNK : PINK	WHT : WHITE
BLU : BLUE	GRY : GREY	PRP, PPL : PURPLE	YLW : YELLOW
BRN : BROWN	ORG : ORANGE	RED : RED	
A*P	: PRINTED CIRCUIT BOARD	PS	: SWITCHING POWER SUPPLY
BS*	: PUSHBUTTON ON/OFF, OPERATION SWITCH	PTC*	: THERMISTOR PTC
BZ, H*O	: BUZZER	Q*	: INSULATED GATE BIPOLAR TRANSISTOR (IGBT)
C*	: CAPACITOR	Q*DI	: EARTH LEAK CIRCUIT BREAKER
AC*, CN*, E*, HA*, HE*, HL*, HN*, HR*, MR*_A, MR*_B, S*, U, V,	: CONNECTION, CONNECTOR	Q*L	: OVERLOAD PROTECTOR
W, X*A, K*R_*		Q*M	: THERMO SWITCH
D*, V*D	: DIODE	R*	: RESISTOR
DB*	: DIODE BRIDGE	R*T	: THERMISTOR
DS*	: DIP SWITCH	RC	: RECEIVER
E*H	: HEATER	S*C	: LIMIT SWITCH
F*U, FU* (FOR CHARACTERISTICS, REFER TO PCB INSIDE YOUR UNIT)	: FUSE	S*L	: FLOAT SWITCH
FG*	: CONNECTOR (FRAME GROUND)	S*NPH	: PRESSURE SENSOR (HIGH)
H*	: HARNESS	S*NPL	: PRESSURE SENSOR (LOW)
H*P, LED*, V*L	: PILOT LAMP, LIGHT EMITTING DIODE	S*PH, HPS*	: PRESSURE SWITCH (HIGH)
HAP	: LIGHT EMITTING DIODE (SERVICE MONITOR GREEN)	S*PL	: PRESSURE SWITCH (LOW)
HIGH VOLTAGE	: HIGH VOLTAGE	S*T	: THERMOSTAT
IES	: INTELLIGENT EYE SENSOR	S*RH	: HUMIDITY SENSOR
IPM*	: INTELLIGENT POWER MODULE	S*W, SW*	: OPERATION SWITCH
K*R, KCR, KFR, KHuR, K*M	: MAGNETIC RELAY	SA*, F1S	: SURGE ARRESTOR
L	: LIVE	SR*, WLU	: SIGNAL RECEIVER
L*	: COIL	SS*	: SELECTOR SWITCH
L*R	: REACTOR	SHEET METAL	: TERMINAL STRIP FIXED PLATE
M*	: STEPPER MOTOR	T*R	: TRANSFORMER
M*C	: COMPRESSOR MOTOR	TC, TRC	: TRANSMITTER
M*F	: FAN MOTOR	V*, R*V	: VARISTOR
M*P	: DRAIN PUMP MOTOR	V*R	: DIODE BRIDGE
M*S	: SWING MOTOR	WRC	: WIRELESS REMOTE CONTROLLER
MR*, MRCW*, MRM*, MRN*	: MAGNETIC RELAY	X*	: TERMINAL
N	: NEUTRAL	X*M	: TERMINAL STRIP (BLOCK)
n=*, N=*	: NUMBER OF PASSES THROUGH FERRITE CORE	Y*E	: ELECTRONIC EXPANSION VALVE COIL
PAM	: PULSE-AMPLITUDE MODULATION	Y*R, Y*S	: REVERSING SOLENOID VALVE COIL
PCB*	: PRINTED CIRCUIT BOARD	Z*C	: FERRITE CORE
PM*	: POWER MODULE	ZF, Z*F	: NOISE FILTER

ERC



DAIKIN INDUSTRIES CZECH REPUBLIC s.r.o.

U Nové Hospody 1/1155, 301 00 Plzeň Skvrňany, Czech Republic

DAIKIN EUROPE N.V.

Zandvoordestraat 300, B-8400 Oostende, Belgium

Copyright 2018 Daikin

3P517827-3C 2019.04